

# Kennedy-Wunsch Lecture, 29 May 2019

## A Perspective of Process Metallurgy Research at Auckland

John J.J. Chen

When I was invited to present this lecture, I was somewhat uncertain as to whether I really deserve it. Nevertheless, I accepted the invitation because I consider it a great honour, and I thank the IChemE-NZ Board for the invitation.

It was suggested that I talk about my career, and research on aluminium smelting and its industrial applications, hence the title of my lecture. However, when I began to write the lecture, I found myself like Kennedy(1994): "*..... - but when I began to consider them more seriously, I found myself like the little girl of the story who, pressed for an opinion, got out her pencil and a piece of paper - and asked why she needed these, replied " How will I know what I think until I see what I write?"*". As a result, my presentation is divided into three sections:

- I. Alister Miles Kennedy and Donald Frederick Sandys Wunsch
- II. Chemical and Materials Engineering at the University of Auckland
- III. Process Metallurgy research at Auckland

### **I. Alister Miles Kennedy and Donald Frederick Sandys Wunsch**

About the two gentlemen that this lecture series was named after, Professor Miles Kennedy has already given a good description of Sandys Wunsch (1887-1973) in his inaugural lecture(Kennedy 2010) and further details may be found in the Dictionary of New Zealand Biography. Sandys Wunsch died in 1973, the year I was in my Third Professional Year at the University of Auckland. It is noted that the name Wunsch will come up again later in relation to a discussion of the date of the first accreditation of the Canterbury degree in Section II, under 'History and Connections'.

With regards to Professor Miles Kennedy, previous speakers have already given detailed accounts of his contributions. I will here say something about my personal interactions with him. My first encounter with Miles would have been in 1985 although I did not get to talk with Miles directly as I was then only a recently appointed Lecturer at Auckland. Miles presented an invited talk on Professor Alan Lee Titchener at a retirement function in Auckland for three retiring Professors in September 1985 – but more on this towards the end of Section II.

I have later heard a lot about Miles through a friend and colleague Kevin W. Free who was a member of the Auckland Department from 1986-2000. Kevin won the Junior Moulton Medal(IChemE) 1958 for the paper "The production of solar salt", *TransIChemE*, V. 36A, 115-122, 1958 – as an aside, this paper was based on the ME supervised by Tom Hagyard and the research was mentioned in Kennedy(2010). Kevin is now retired and living in Warkworth. Like Miles, Kevin was a member of the Defense Scientific Corps, went to Cambridge at about the same time and he was mentioned numerous times in Professor Kennedy's inaugural Kennedy-Wunsch Lecture. Kevin is the person referred to by Miles as "*...his classmate who became a member of the Delaware State Legislature.*" Kennedy(1994)

My first direct contact with Professor Kennedy was, however, through fax exchanges and a telephone conversation when I was planning my sabbatical leave for 1992 with one of my stops being the National University of Singapore. NUS wanted Professor Kennedy to have 'a chat' with me prior to agreeing to host my sabbatical visit. The following is part of a fax sent to me by Professor Kennedy.

07/08/91

09:22

SCHOOL OF ENG UNIVERSITY CANT

001



FAX FROM:

PROFESSOR A M KENNEDY

Department of Chemical and Process Engineering  
University of Canterbury, Private Bag, Christchurch, New Zealand

Phone: (Bus) 64 3 642 139  
(Home) 64 3 3325-312

FAX No: 64 3 642 705

To: University of Auckland Fax Number: 64 9 366 0702  
Attention: Dr. John Chen Date: 7/8/91 No of Pages: 1  
Chemical & Materials Eng.

Dear John,

Sorry I missed your call. I tried  
again later, but we don't seem to coincide.

Kind regards,  
Miles Kennedy

If this transmission is faulty, please contact me.

I looked through past Kennedy-Wunsch lectures and am surprised that there is no mention of Miles' research publications. Miles, of course, published a series of classics with the legendary Peter Victor Danckwerts (PVD), GC, FRS. Miles, in his inaugural Kennedy-Wunsch lecture devoted only one paragraph to it and in it, said "I won't bore you with details of that far-off research".

I have referred students to these classics when teaching mass transfer, gas absorption, film model, penetration/surface renewal model, etc., not just because they are classics, but also to allow the students to relate the subject matter to a real person, and in this case, Professor Miles Kennedy of Canterbury. In my opinion, in so doing, it greatly helps the students in their recall of the subject matter.

By the way, there will be more on "Gas Absorption", "film model" and "surface renewal model" in Section III. Suffice to say here that a major efficiency parameter in aluminium electrolysis, viz the (Faradaic) Current Efficiency, is in fact governed by a fundamental chemical engineering process: gas absorption with chemical reaction.

It would be appropriate to show a screen-shot of the title of one of these classics and I have listed the full references of these classics (Danckwerts & Kennedy, 1954a, 1954b, 1958, 1963). The screenshot shows the reference as Trans IChemE,

Vol. 75, December 1997, pages S101-S104. The article was re-published in 1997, in the Jubilee Supplement-A Celebration of Achievement, Trans IChemE, Vol. 75, December 1997. "Nomination of papers to be included in this issue were sought not only from the Editors, but also more widely within the Institution" wrote Geoff Hewitt, the Honorary Editor. The article's original reference was Trans IChemE, 32(Supplement): S49-S52, 1954. It is noted that IChemE was founded 1922.



Chemical Engineering Research and Design

Volume 75, Supplement, December 1997, Pages S101-S104



## Kinetics of liquid-film process in gas absorption. Part I: Models of the absorption process

P.V. Danckwerts G.C., M.B.E., M.A., S.M. \*, A.M. Kennedy B.E., B.Sc. \*

\* Department of Chemical Engineering, Tennis Court Road, Cambridge.

Received 1 December 1953, Available online 19 November 2008.

[Show less](#)

[https://doi.org/10.1016/S0263-8762\(97\)80007-X](https://doi.org/10.1016/S0263-8762(97)80007-X)

[Get rights and content](#)

In addition to referring the students to these classics in mass transfer, in order to further reinforced the 'association' by the students in their learning, I also include a further 'human touch' by showing the following figure from the book by Varey(2012) - Text and photo taken from p. 179 of Varey(2012), and the 'note' by PVD from Kennedy(2015). Professor Kennedy, in his inaugural lecture, mentioned that the book was then being written. Clues as to why Professor Kennedy was referred to as 'Brigadier' may be found in his Inaugural Lecture, elsewhere in this paper, and detailed in Varey(2012).

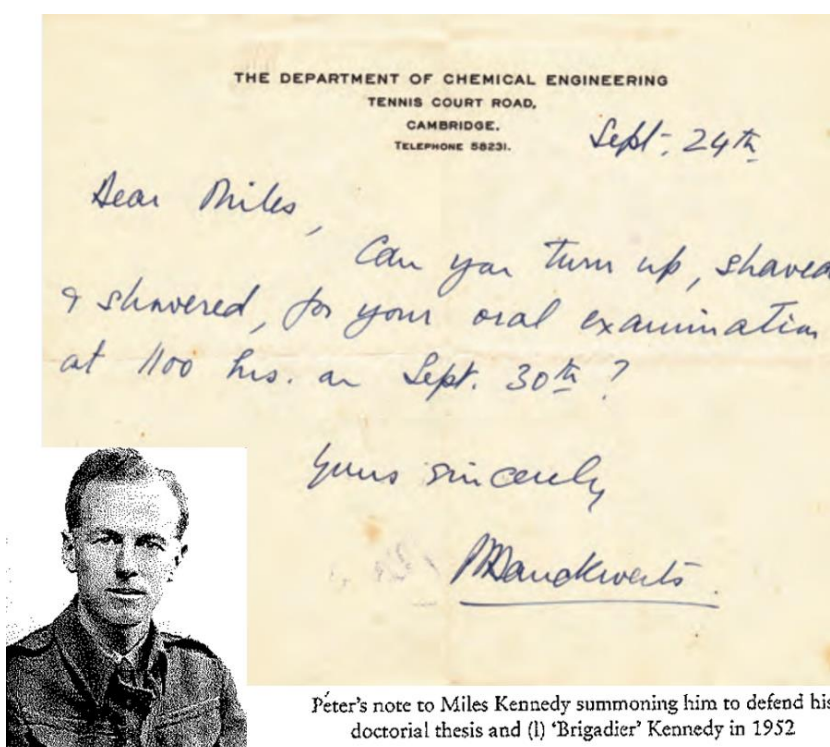

Peter's note to Miles Kennedy summoning him to defend his doctoral thesis and (!) 'Brigadier' Kennedy in 1952

## **II. Chemical and Materials Engineering (C&M) at the University of Auckland**

As I am the second Auckland C&M graduate and the first C&M academic to give the K-W Lecture, and having been the HoD from September 1996-January 2004, I would like to dwell somewhat on the C&M Department.

### **Auckland C&M, with a brief comparison to Canterbury CAPE.**

It is interesting to note the following quotes in relation to chemical engineering at Canterbury:

Kennedy(1974): *"Denham foresaw the growing importance of the engineer-chemists and the chemical engineers in industry, but he believed that these people would be essentially chemists, not engineers. Certainly my own department, like many others, was fostered in a chemistry basement; but, like these others, it has long since been adopted by an engineering school. This is a recognition of the fact that the chemical engineer is essentially an engineer, not a chemist."*

Kennedy(1981): *"At Canterbury....., chemical engineering had emerged as a spin-off from a chemistry department."*

Williamson(1994) : *"Chemical engineering training has become more concerned with the generalisation of "process" behaviour – its dynamics and control than with the details of the particular process such as its chemistry. Indeed it is now possible for a chemical engineer to graduate with a formal exposure to chemistry which corresponds to only a part of second year university chemistry."*

*By 1951 the University Council had resolved after requesting Stan Siemon's views to establish "a department of Chemical Engineering within the framework of the School of Engineering" and in 1956 the Minister of Education wrote to the Registrar assenting to the establishment of a Chair of Chemical Engineering. In 1960 with the move to Ilam, Chemical Engineering became physically part of the School of Engineering and ties to the Chemistry Department began to break."*

While Canterbury grew out of a Chemistry Department, its strong link to mechanical engineering is evident from the following quotes.

Kennedy(1981): *"When the Canterbury degree was introduced, the course was a five-year one containing most of the elements of a B.Sc. degree in chemistry and a BE in mechanical engineering, with a few extra subjects like surveying, industrial microbiology and economic geology thrown in for good measure."*

Kennedy(2010): *"After the normal Intermediate, the First Professional year was to be as for the BE(Mechanical), as was the Second Professional year plus Stage 2 Chemistry. The Third Professional year was to include Chemistry 3 and a new subject called Applied Chemistry, plus Heat Engines and Economic Geology...."*

The founding of the Auckland Department is summarised in the following excerpt from a letter by Professor George Ferguson, in his then capacity as Acting Head, to

the VC, Sir Colin Maiden, on "Review of Department of Chemical and Materials Engineering" August 1979:

*The Chair in Chemical and Materials Engineering was established in 1965 and the first students to enrol commenced first Professional in 1967. This year was spent at Ardmore and the following and subsequent years in the new building in Symonds Street. The dual nature of the department namely chemical and materials engineering arose from the need to train metallurgical engineers in the country. The School of Mines at Otago which produced a B.E. Metallurgy was closed in, I think 1964 and hence there was a necessity to give metallurgical training elsewhere. The concept of putting materials with chemical engineering is an obvious one for all the process operations normally taught in a metallurgy degree can be done and done better in chemical engineering and all that then remains to be taught is the physical properties of materials. Thus the concept allowed the survival of metallurgy and materials teaching in New Zealand and Professor A. L. Titchener's foresight in this matter is to be commended. Professor Titchener was the foundation Professor.*

The 1960-80s was the time of the 'think big' schemes with significant metallurgical and process industries being established in New Zealand: Pacific Steel(~1962), NZ Steel(~1968), New Zealand Point Aluminium Smelters(~1971), Marsden Point Refinery(~1964), etc.

Professor Alan Lee Titchener was previously in the Mechanical Engineering Department (1958-1967), and Professor and Head of that Department from 1962-1967. He served twice as Dean of Engineering(1965-1968, 1974-1977). He was appointed Foundation Professor of Chemical and Materials Engineering in 1967.

Thus, one may argue that the Auckland department is a spin-off from Mechanical Engineering.

Professor Alan Lee Titchener(1920-1994), often affectionately referred to as the Big-T, or Titch, retired in 1985. He passed away in Auckland, 23 June 1994. Emeritus Professor George Ferguson (who was Professor Titchener's second PhD student – the first being (now Sir) Graeme Davies) said of him: *"He had built a very good foundation for the department, with a strong ethic in teaching and research. He had insisted on high academic standards and quality in all matters-sometimes to the discomfort of students. He demanded high standards of himself and expected this behaviour in others. He was always prepared to say what he thought, no matter how unpalatable the message."* Ferguson(2017).

I think it appropriate to include a brief academic CV of Titch:

1938-1942	Otago	BE(Mining), B.Sc. A.O.S.M.
1944	Otago	Junior Lecturer in Metallurgy
1946-1947	Canterbury	BE(Mech.)
1951-1955	Auckland (Mech.)	Lecturer(1951-1954) Senior Lecturer(1954-1955)
1955-1958	M.I.T.(Cambridge)	Sc.D. in metallurgy (Special leave from Auckland)
1958-1967	Auckland (Mech.)	Senior Lecturer(1958-1961) Assoc. Prof. (1961-1962) Professor and HoD, Mech. Engng. 1962-67
1967-1986	Auckland	Foundation Chair and HoD Chemical and Materials Engineering Dept.
1979-1981	NZ Liquid Fuels	Technical Director. On secondment from



Jan 1986

Trust Board

Auckland

Retired. Emeritus Professor.

The first cohort of Chemical and Materials Engineering students started their Intermediate year in 1966 and they experienced the move of the School of Engineering from Ardmore back to the Symonds Street site:

- 1966 Intermediate, City Campus
- 1967 1<sup>st</sup> Professional, Ardmore
- 1968 2<sup>nd</sup> Professional, am City Campus/pm Ardmore
- 1969 3<sup>rd</sup> Professional, City Campus

## C&M Graduates

Although Dobbie(2018) said, in his Kennedy-Wunsch lecture: "*I found relatively little difference in general capability between the New Zealand universities, or indeed between chemical engineers from other countries.*", Fail(2014) elaborated on the importance of corrosion, and Marshall(2011) on materials of construction.

The Auckland Chemical and Materials Engineering programme with a strong materials flavour provides a robust materials science and engineering education without diluting the chemical and process engineering content and so can deal with process design and operation from a materials perspective. It is particularly suited for today's manufacturing industry, where, it is not just process engineering efficiency that is important, reliability engineering is also crucial in order to ensure the maximum possible on-stream time of production facilities. A good understanding of materials behaviour, selection, and performance is crucial to reliability engineering, thus striking an acceptable balance between the cost of materials for constructing the process equipment and asset reliability, in order to ensure that a production plant remains sustainable and commercially competitive.

It is appropriate here to consider the following from Kennedy(1994): "*I think back over some of the graduates from my own department. The ones who went into family businesses: farming; making carpets or mattresses; growing apples; selling stamps. The graduate who became an actor; the two who became ministers of religion. The two who went into banking, and the one into insurance. The property speculator; the schoolteachers, and the librarian. The one who founded a computer software firm, and his classmate who became a member of the Delaware State Legislature. As far as I know, these men and women did not regret having spent four or five years obtaining a chemical engineering degree. I believe they gained an education, even if we failed to train them for their eventual occupations.*"

At the Auckland Faculty of Engineering, we also recognise the wider education aspect of an engineering education as alluded to above by Professor Kennedy. In an attempt to address this, the Auckland degree has since 2011 introduced a systems engineering course that 'takes students into a socio-economic and political environment as well as an engineering one' over Years 2 to 4 of the degree programme. In Year 2, students work in teams of three, progressing to multiple-engineering discipline teams of 25 that involve all year 4 students from the entire Faculty of Engineering. In the process, students need to learn to manage ambiguity and complexity, and to progress problems in a methodical rather than ad hoc manner. For details, see Robinson(2013), University of Auckland News(17 Oct 2013).

The Department can also boast a number of notable achievements:

- Dr Sue Truman, first woman appointed to the Faculty's academic staff as a junior lecturer in 1975 (Bassett, p. 151, 2003)
- The first woman engineering PhD, Dr Sue Truman (nee Peart), supervised by Roy Sharp and Colin Adam, in 1978. She was also one of the first two women pilots employed by Air New Zealand (Bassett, p. 125, 151, 2003; Auckland Star, 2 November 1979)
- Professor Margaret Hyland, first woman engineering professor in the Faculty, 2012
- Richard Beal, Rhodes Scholar, 2005
- Many of our graduates have gone into different fields and hold top management positions in industries domestically and internationally, in such industries as Dairy, Pulp and Paper, Power, Oil and Gas etc.
- Recently, a C&M graduate, Agnes Loheni, was sworn in as a Member of the NZ Parliament

## Research in the C&M Department

It is interesting here to quote from Kennedy about H.G. Denham(1880-1943) (Kennedy, 1981, 2010; refer also Denham, 1924; Donnan, 1943), Professor of Chemistry, Rector of Canterbury College, and Chairman of the New Zealand Council of Scientific and Industrial Research in 1934, who said, among other things, "*in chemical engineering there lies the greatest and the most lucrative field of development for engineering science*". This notion, I believe, is very well exemplified by the range of research topics carried out at the Auckland Chemical and Materials Engineering Department.

Research in the early days of the department since its foundation in 1967 was mainly in the areas of various aspects of metallurgy of iron and aluminium alloys, wood and its properties including fracture behaviours, the flow of pulp suspension, two-phase gas-liquid flow, absorption in packed columns, etc. It was also in this period that Professor Titchener wrote a series of articles on engineering manpower and education, as well as on energy and liquid fuels in relation to his secondment as the Director of the Liquid Fuels Trust Board. In the 1980s, there was research work being conducted relating to the dairy industries, and research strength in aluminium smelting was established.

By the late 1990s, Bassett(2003, p. 138) described the Department as follows:

*The Department of Chemical and Materials Engineering was experiencing some gradual shifts in its research focus by the end of the 90s. In 1999 it had 30 PhD students spread over its four main fields of materials science, food technology, process metallurgy, and pulp and paper research. Research in materials engineering had begun with Alan Titchener's work on testing the strength and properties of materials, but 30 years later students were more concerned to explore the properties of coatings, researching semiconductors, ceramics, and nano-structural materials. Food research concentrated on the qualities of texture and taste resulting, for example, from the balance of air bubbles and fat globules in ice cream. Investigating the microstructure of food products was a natural progression from the early work on materials such as metals. Other research projects explored the most efficient processes for cooking, chilling and storing food. In the area of*

*food process engineering the concerns of chemical and materials engineers overlap when considering questions of mass and heat transfer, and the effect of the microstructure of the various components on the 'mouth-feel' of the resultant product.*

Thus, increasingly, there is a very strong synergy between materials and process that take advantage of the materials and process engineering expertise within the department.

Today, there are 46 PhD students and 5 Masters by research registered in the Department, and the department's research strengths, its focus, and definitely its strategic goals lie in meeting the immediate challenge areas for current and future chemical engineers as outlined by the Institute of Chemical Engineers – these being the global demands for (1) Water, (2) Energy, (3) Food and Nutrition, and (4) Health and Well Being(Thambyah, 2019). The research topics include:

- waste water treatment and the development of high-performing membranes
- food process control engineering
- food texture and mechanical properties
- high pressure processing
- 3D printing of food
- tissue engineering meat
- new materials that can be used to conserve energy in insulating buildings
- Energy Storage materials and even upcycling of large batteries and electronics to recover valuable metals
- spray drying techniques
- tissue and joint mechanics and materials
- surface characterization of potential implant material
- novel transition metal oxide semiconductors and surface engineered coatings
- spray coat and control the process that allows for unique structuring and functionalities

In addition, the Product Accelerator in which millions of dollars of funding have been translated to many times the investment amount in terms of supporting innovation and commercialisation of new materials and processes is led by Professor Mark Taylor who is associated with the Department.

## **Research Performance & Strength of C&M**

The Department can boast a total of 7 Fellows of the Royal Society of New Zealand amongst its Emeritus, past and current Professors who were elected to the National Academy '*for distinction in research or for advancing science, technology and the humanities*', while in the Department and based on research conducted in the Department. The list is as follows, with the date of election:

1. Geoff Duffy(1987), Emeritus Professor
2. Barry Welch(1989), Emeritus Professor
3. John Chen(1996)
4. Dong Chen(2000), now Professor, Soochow University
5. Wei Gao(2001)
6. Neil Broom(2008), Emeritus Professor
7. Margaret Hyland (2018), now Vice Provost(Research), VUW



The research performance and strength may be further illustrated by the results of the recent 2018 PBRF (Performance Based Research Funding) 2012-2018 evaluation round published by the Tertiary Education Commission (TEC) on 30 April 2019. The following table is a comparison of the Auckland C&M Department with All University of Auckland Engineering & Technology, All NZ Institutions Engineering & Technology, and All NZ Institutions. Note particularly the number of 'A' grade researchers, A%, and (A+B)% in the Auckland Department.

It is most pleasing to note that one-third of the academic staff in the Auckland Department are rated by TEC as 'A' grade researchers. The quality categories are described by TEC as:

- A – peer recognition for their research at a world-class level
- B – peer recognition for their research at a national level
- C – peer recognition for their research and indicates a contribution to the research environment within their organisation or the wider community
- C(NE) – contains evidence of quality-assured research outputs produced, but may have limited or no research-related activity in the research contribution component (can be awarded to new and emerging (NE) researchers).

	A	A%	B	B%	(A+B)%	C	C%	C(NE)	C(NE)%	Total
<b>Univ Auck Chem &amp; Matis Engng</b>	<b>9</b>	<b>33.0%</b>	10.5	38.5%	<b>71.4%</b>	4.8	17.6%	3	11.0%	27.3
Univ Auck (Engng & Tech)	<b>48.85</b>	<b>23.2%</b>	96.56	45.9%	<b>69.2%</b>	18.68	8.9%	46.13	21.9%	210.22
All NZ Institutions (Engng & Tech)	<b>103.19</b>	<b>18.4%</b>	235.86	42.0%	<b>60.4%</b>	117.9	21.0%	104.61	18.6%	561.56
All NZ Institutions	<b>1168.52</b>	<b>15.8%</b>	2974.66	40.2%	<b>55.9%</b>	2155.52	29.1%	1109.7	15.0%	7408.4

### **'History and Connections'**

Let me now consider what might be grouped under 'history and connections'. In Professor Kennedy's Inaugural Lecture, he wrote:

*".....William Ernest Russell. I haven't mentioned Bill Russell before. He was a chemical engineering pioneer in the Sandys Wunsch mould, but it was with the fertiliser industry that Bill left his legacy. As well as starting a chemical engineering dynasty with son David and grandson Bruce, both Auckland graduates, Bill chaired the IChemE Panel that carried out the first Moderation of the Canterbury degree in 1978."*

There are at least three further pieces of information that I can add to the above.

- Bill Russell also chaired the IChemE panel that carried out the Moderation of the Auckland degree, in 1980. There were 5 panel members, and Professor R.L. Earle and Dr B.V. Walker were in both the Canterbury and the Auckland panels.
- Bill's son David is a friend and he was in the same C&M class as me from 1971-1973 and I have stayed in contact with him.
- Bill's grandson Bruce went through the Auckland C&M degree and had been taught by me. He went on to complete a PhD in 2004 at the same Cambridge department that Miles did his PhD some 50 years previously.

With reference to Professor Kennedy's reference to the "first Moderation" in 1978, I was puzzled to note that Jones(2013) wrote "...based on the fact that the C&M course at Auckland was not accredited during my time there, and was not first accredited until 1974..." and the following line in an interview of Professor Kennedy as President of the then NZIE (McEldowney, New Zealand Engineering, 1980):

*"Professor Kennedy's own department was moderated last year by the Institution of Chemical Engineers, which sent a committee of four to the school for a day, They reported that the department, which was last moderated many years ago, still meets I.Chem.E. standards."*

Thus, from the above, if Canterbury's "first moderation" was in 1980, it would be most unlikely that Auckland's moderation as noted by Jones(2013) pre-dated Canterbury's. In the NZIE interview(McEldowney 1980), it was clearly implied that a moderation at Canterbury took place before the 1978 exercise.

The following were obtained with the assistance of Peter Slane, Regional Director of IChemE, and staff at IChemE, Rugby (Slane, 2019).

### Canterbury

From **intake** year 1948.....in some of the Annual Reports of the Council..... found the following extract in the report for the year ending December 1948 and this is where that date comes from:

*"An application for recognition of the degree course in Engineering (Chemical) was received from Canterbury University College, Christchurch, New Zealand. This was investigated on behalf of the Council by Messrs S Irwin Crookes, D F Sandys Wunsch and W A Joiner, and on their recommendation, the Council has recognised the course, for a period of three years, as exempting those who satisfactorily complete it from Papers C, D, E and F of the Associate-Membership Examination of the Institution."*

Note: "Associate membership" is what we now know as Chartered membership.

### Auckland

BE in Chemical and Materials Engineering – accreditation with effect from 1974 **graduation**. This was a four-year degree programme so this accreditation would cover students commencing the degree from intake year 1971.

It is, of course, most appropriate that D.F. Sandys Wunsch(sic) was involved in the 1948 accreditation of the Canterbury degree. S. Irwin Crookes, D F Sandys Wunsch and W A Joiner were all pioneer chemical engineers in New Zealand. The name WA Joiner has been mentioned multiple times in Professor Kennedy's Inaugural Lecture. The entry for Samuel Irwin Crookes(1871-1955) in an Engineering New Zealand website begins thus *"Samuel Irwin Crookes was New Zealand Institution of Engineers' (now the Institution of Professional Engineers New Zealand (IPENZ)) President in 1938-39 and a Vice President of the Institution of Chemical Engineers, London."* Further, *"He designed the large chemical plants for the manufacture of superphosphate at Te Papapa and New Plymouth. He also did work at the Portland Cement works near Whangarei."* *"He was also a prime mover in the establishment of the NZ Fertiliser manufactures Research Association laboratories at East Tamaki"*. In addition, he was a member of the Auckland University College Council as well as many other local institutions and bodies.

The above information was shared with Professor Kennedy, who told me that he might have been quoting from the report of the 1978 Moderating panel which has this statement: *'Although there had, at some times unknown in the past, been an assessment of the course made by individuals on behalf of the Institution, it appeared that a more formal and regular (say 5 or 10 year interval) check is now envisaged . . .'* By the way, exactly the same statement also appeared in the report of the 1980 Auckland Moderation Report.

Professor Kennedy also said: *"I was still a student in 1948 and it's unlikely we would have been involved, if indeed the panel visited the department. I had never*

come across a reference to this until now - even as HOD with access to all the department's files. It's a particularly nice touch that Sandys Wunsch himself was involved." and Professor Kennedy also added a note to me stating that "it would be appropriate for you to follow the quotation with a correction about the first moderation, based on your findings."

Professor Kennedy also said this: "At the 21/3/47 Engineering Faculty meeting, Stan Siemon moved that "this Faculty formally applies to the Institution of Chemical Engineers, for the BE(Chemical) degree to be recognised". Maybe the 1948 moderation was a consequence."

Professor Kennedy further commented that while the first accreditation was conducted in 1948, with Papers C, D, E and F being exempted, there was no credit for the "Home Paper" which was a "massive exercise, leading to more than one marital breakdown" (Kennedy, 2019)

Even in 1956, Professor Kennedy argued that he "should be exempt because of the amount of design in our degree (culminating in a 5-day examination)" but got nowhere. It wasn't until 1966 that exemption from the Home Paper was granted.

While on the subject of 'history' and 'connections', here is another interesting anecdote. When Denham died on 15 February 1943, Professor John Packer succeeded him and played a major role in the formative days of the Canterbury degree. Although Packer had not ".....previously warmed to Denham's concepts for the industrial courses but John Packer was a man of outstanding integrity; in his new role he made it his duty to bring them to fruition." (Pollard, 1994). ", and "..... John Packer, ....., took over his negotiations with the Council, arguing that they were a "matter of considerable national importance. And one of some urgency . . . as a result of the changed conditions resulting from the war." In October 1943, the Government approved a grant of £1100 to establish Chemical Engineering....." Kennedy(2010). Retired Associate John E. Packer, son of Professor Packer, of the then Auckland Department of Chemistry, taught, in the late 1980's and early 1990's, analytical chemistry to Year 2 and organic chemistry (polymer and biochemistry mainly) to Year 3 in the Auckland Chemical and Materials Engineering degree programme. I recall John(Junior) telling me about his father's connection with chemical engineering at Canterbury. John recently told me that: "I remember the arrival of Stan Siemon and knew him well. Dad was also a driving force in the dissolution of the University of NZ and along with F.J. Lewellyn and Dame Ngaio Marsh he was given the first honorary doctorate of the new University of Canterbury." (Packer 2019).

### **Professor AL Titchener, based on a paper by Professor AM Kennedy**

To end this section, I would like to return to the Foundation Chair of the Department of Chemical and Materials Engineering by referring to a retirement function for him, and two other professors, in 1985 of which Professor Miles Kennedy was an invited speaker. Professor Kennedy's speech was on Professor Titchener's achievements in the areas of engineering, education and energy. The presentation was published in the IPENZ Transactions after Professor Titchener's death (Kennedy 1994). A screenshot of the title page and the Introduction is shown below



# Engineering, education and energy: Some contributions of Alan Lee Titchener

Miles Kennedy,<sup>1</sup> BE, BSc, PhD, FIChemE, MIPENZ(Fellow)

*A distinguished member of IPENZ, Emeritus Professor A L Titchener, died on 23 June 1994. Alan Titchener contributed many papers to the Institution's journals, and received many prizes and awards - most notably, the F W MacLean Citation in 1986. Professor Titchener retired from the School of Engineering at the University of Auckland at the beginning of 1986, having spent 34 years there as Lecturer, Senior Lecturer, Associate Professor, then Professor and Head of the Department of Mechanical Engineering; Foundation Professor and Head of the Department of Chemical and Materials Engineering; and Dean of Engineering on two separate occasions. The School arranged a seminar on 6 September 1985 to honour Alan Titchener and two colleagues, Arved Raudkivi and Peter Taylor. The following contribution is based on a presentation at that seminar, and touches on aspects of Alan Titchener's work which lay outside the mainstream of engineering.*

## 1. Introduction

When I was asked to speak about Professor Titchener at a retirement seminar being arranged as a tribute to him and to two of his colleagues, I thought that should not be too difficult. After all, I had known Alan for 20 years or more. So when Professor George Ferguson asked me for a title and a text, I gave him a title without worrying too much about the text. I had a few ideas of course - or thought I had - but when I began to consider them more seriously, I found myself like the little girl of the story who, pressed for an opinion, got out her pencil and a piece of paper - and asked why she needed these, replied "How will I know what I think until I see what I write?"

*<sup>1</sup>Emeritus Professor, Department of Chemical and Process Engineering, University of Canterbury, Christchurch*

*This paper was received on 12 August 1994.*

*The Institution of Professional Engineers New Zealand*

23

This is a very thought-provoking paper and is highly worth reading. I thought it appropriate to quote a few paragraphs from the paper.

### On Engineering:

## 2. Engineering

Let me first remind you of Professor Titchener's work on the problems of educating professional engineers. In 1961, he carried out a study for the University Grants Committee on the demand for and supply of professional engineers in New Zealand. I have not seen the original report, but it was undoubtedly an important and influential document. It was as a direct consequence of this work that the UGC took a far-reaching decision to build the Auckland School of Engineering and enlarge the Canterbury School to provide for 700 professional students at each centre.

## On Education:

### 3. Education

I should like now to turn briefly to the wider university scene. Alan Titchener wrote two papers which I have gone back to many times, when considering the purposes of a university. One was an address on "The function of the university in New Zealand and the relevance of its teaching and research to the needs of the country", given in May 1969 to the Conference of Universities. The second was a paper on "The role of the university - as it was, is now, and some day may be", given a year later to the Annual Conference of the Association of University Teachers.

These papers link the past to the future. They describe our universities as they are and as they might be. They look at the functions of the university; the impact of science and technology on the liberal tradition of university education; the criticisms made of our universities by the community, in teaching and research. They ask and answer such questions as:

What is education?

## On Energy:

### 4. Energy

When I included the word "energy" in my title, I was thinking in part of the immense energy displayed by Professor Titchener over the years I had known him, but also of the part he had played as a member of the Auckland triumvirate of Maiden, Meyer, and Titchener, who did so much to influence government thinking and private and public sector planning and action in the energy field.

One cannot do justice in a few words to Alan's contributions - but they speak for themselves and will be familiar to many readers: his involvement with NZERDC; his chairmanship of the CNG Co-ordination Committee and membership of the Biomass Co-ordinating Group; and most of all, his work as Technical Director of the LFTB, particularly in the development of the natural-gas liquids, coal and alcohol fuels programmes.

The following photograph was taken during the day of the function. Professor Miles Kennedy is the second person from the RHS. Photo from NZ Engineering, April 1, p. 20, 1986.



Professor Titchener (fifth from right) with colleagues when a seminar was held at the School of Engineering, University Auckland, last year to farewell him and Professors Araved Raudkivi (sixth from right) and Peter Taylor (second from left).



### **III. Process Metallurgy research at Auckland**

I will now turn to process metallurgy research at Auckland.

#### **Overview**

#### **Light Metals/Aluminium Technology research**

In 1980, Professor Barry Welch was appointed as the second Professor of Chemical and Materials Engineering. He initiated research into aluminium smelting and related technology in the Department. Participating academic members include:

Barry Welch, appointed 1980; Emeritus Professor since 1998

John Chen(C&M), appointed 1984. Physical modelling of aluminium smelting, molten metal treatment.

Jim Metson (Chemistry), appointed 1985. Alumina refining, gas dry-scrubbing. Now DVC(Research), Auckland

Margaret Hyland (C&M), appointed 1991. Hydrogen fluoride adsorption, alumina. Now Vice-Provost(Research), VUW

Hans Müller-Steinhagen (C&M), 1986-1993 in C&M. Heat transfer and fouling in bauxite refineries. Now Rector (VC), Technische Universität Dresden

Mark Taylor, then at Comalco Research Centre in Melbourne, collaborated with the group in Auckland. In 2002, he was recruited to be the Director of the Light Metals Research Centre(LMRC) after being Production Manager at New Zealand Aluminium Smelters(NZAS), Upgrade Implementation Manager at NZAS, GM Technical for Comalco (1998) and GM Operations (2000) at Comalco's largest smelting operation, Boyne Smelters Ltd, in Queensland. He is now Professor in C&M, and Director of NZ Product Accelerator Programme.

## International Prominence

When appointed to Auckland, Professor Barry Welch was already a world authority on aluminium smelting technology. In 1993, the Aluminium research group gained international prominence as can be seen from the following that appeared on the front page of the University of Auckland News, April 1993. The reputation of the Light Metals research group was thus firmly established internationally.



The University of Auckland

Volume 23 Number 3 April 1993

# NEWS

## Shared funding boosts research

University of Auckland engineering researchers dominated a recent award ceremony in the United States.

Staff, students and graduates from the Chemical and Materials Engineering Department won three of the four awards offered for the best publications in four areas in the American journal *Light Metals*.

The awards were established 10 years ago by the Minerals Metals and Materials Society of the American Institute of Metallurgical Engineers to encourage excellence in research and publications. They attract papers from leading research institutes around the world in the four areas of:

- ◆ Mineral processing (especially alumina and bauxite)
- ◆ Metallurgical reduction technology
- ◆ Non-metallic materials technology (especially carbon composites)
- ◆ Metal treatment technology (cast shop and recycling, etc)



Award winning Chemical and Materials Engineering Department researchers (from left) Associate-Professor Hans Müller-Steinhagen, Professor Barry Welch and Associate-Professor John Chen.

In the first category Associate-Professor Hans Müller-Steinhagen and Professor Mohamad Jamialahmadi (a former postdoctoral fellow at the University) won the award for their paper “Convective and subcooled boiling heat transfer to BAYER process liquor”.

A paper on “The interaction between current efficiency and energy balance in aluminium reduction cells” by Associate-Professor John Chen, Wei Dong Zhang and Chemical and Materials Engineering graduates Mark Taylor and Fiona Stevens, who now work for the Comalco Research Centre, took the reduction technology award.

Professor Barry Welch, Seralyn Hume, and Mark Utley joined forces with R. Perruchoud of R&D Carbon to produce a paper on “The influence of low current densities on anode performance” which was named best paper in non-metallic materials (carbon).

The University did not submit any papers in the metal treatment area. In the 1991 *Light Metals* awards a publication by Auckland doctoral student Mark Smith won the carbonaceous materials category.

## Formation of the Light Metals Research Centre (LMRC), 2002

In 2002, the Light Metals Research Centre was formally established with Mark Taylor recruited to be the Director. The follow excerpt from McIntosh, Agbenyegah & Metson(2015) gives a brief description of the Light Metals Research Centre.

*Founded in 2002 based on the research histories of Professors Barry Welch, John Chen, Margaret Hyland and Jim Metson, and Academic Director Mark Taylor, the LMRC at the University of Auckland has established an international reputation for world-leading expertise in the alumina refining and primary aluminium smelting industries. LMRC focusses on providing independent research and development capabilities, consulting services as well as industry-relevant training programmes such as the successful Postgraduate Certificate in Light Metals Reduction Technology from the University of Auckland. Since its inception, LMRC has seen the founding academic staff more involved in leading and guiding research more fundamental in nature, while still maintaining strong ties to the other centre activities. Indeed, LMRC has co-hosted anumber of postgraduate students in areas of fundamental research such as alumina properties, gas adsorption and electrolyte chemistry, supervised within the Departments of Chemical and Materials Engineering and the School of Chemical Sciences.*

## Process Metallurgy Research I was associated with

In what follows, I will mostly refer to work that I was associated with and it will be more of a 'pictorial' tour. Some of the relevant sources will be cited within the text.

Almost all the work discussed was conducted in collaboration with industries, and the purposes for the research were related to one or more of the following:

- Exploring feasibilities and new possibilities
- Provide inputs into models used in the design, modification, and/or efficiency improvement of the process

## Fluid Flow, Heat/Mass Transfer in an Aluminium Smelting Cell

The following figure shows a schematic transverse cross-section of an aluminium cell. Various design modifications have been carried out to control or minimise the electro-magnetic effects. As a result, effects due to gas-induced flows have become significant.

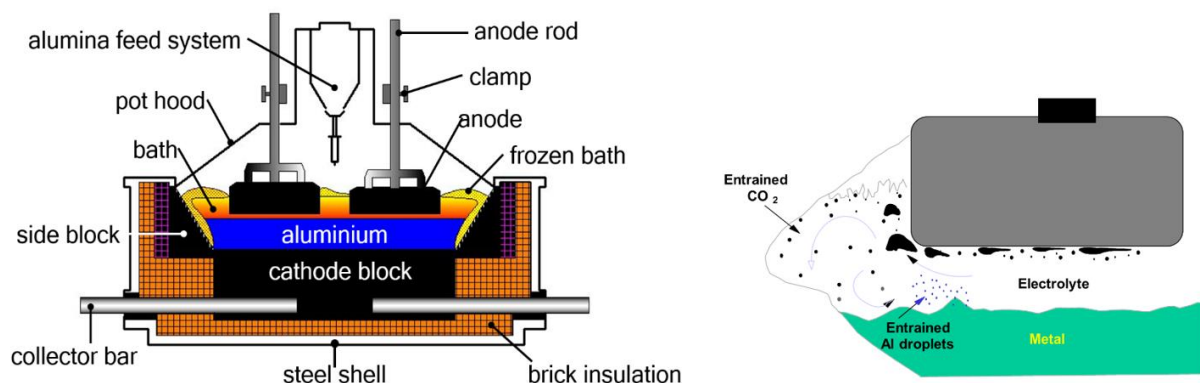

The shape and size, and the rate of evacuation of the bubbles affect the cell voltage and hence the energy efficiency, and the back-reaction between the anode gas and the metal produced has become the predominant cause of the loss of Faradaic current efficiency.

The circulation in the bath and metal layers and the behaviour of the interface affect the freezing/melting of, and heat loss through, the side ledge. Thus, in Figure 8, the areas that we are particularly interested in are the gas bubbles directly under the anodes, CO<sub>2</sub> and aluminium diffusion, the electrolyte and the metals layer and their interface, and their interactions with the side ledge.

As in any chemical engineering operations, the processes involved are very complex and are not always amenable to theoretical and fundamental consideration, and various tools including phenomenological studies, dimensional analysis, computer modelling, etc., need to be employed to understand the problem.

Some of the fundamental works that we have conducted are illustrated in the following two examples. As alluded to in Section I, a major efficiency parameter in aluminium electrolysis, viz the (Faradaic) Current Efficiency, is in fact governed by a fundamental chemical engineering process: "**gas absorption**" with chemical reaction. Carbon dioxide from the anode gas bubbles diffuses into the electrolyte where it meets and react spontaneously with dissolved aluminium metal - referred to in the industry as the back-reaction. Much has been done in minimising this back-reaction resulting in an improvement of current efficiency from the low 80% in the 1970s to more than 95% today.

We applied the theory in Levenspiel (Chemical Reaction Engineering p. 413, 2<sup>nd</sup> Ed.) and in Danckwerts (Gas-Liquid Reaction, p. 111, 1970) and re-worked the "enhancement factor" based on the "**film model**" to arrive at a more realistic expression of the loss of current efficiency. (Chen & Taylor, *Electrochimica Acta*, 35, 109-110, 1990)

We also re-worked the energy requirement using fundamental thermodynamics to improve on previously accepted values (Chen, Taylor & Welch, *Erzmetall*, 45, 468-470, 1992.)

Some of the phenomenological work include the studies of the behaviour of bubbles under a downward facing surface as would occur under an aluminium smelting anode. (Eg. "*Gas bubble formation and rise velocity beneath a downward facing inclined surface submerged in a liquid*", *Chemeca 90*, selected for re-publication in *Trans. I.Chem.E.*, 69, Part A, 25-29, 1991)

The following show views from an angle approximately 30° below the horizontal of bubbles formed by injecting air at a rate of 10mL/s (left) and 63mL/s(right) via a 5mm tube through a submerged downward facing surface inclined at 2.4° to the horizontal. From *Che, Chen & Taylor, CHEMECA 90, Proc. 18th Australasian Chemical Engineering Conference, 384-391, Auckland, August 27-30, 1990. Selected for re-publication in Trans. I.Chem.E. (London), 69, Part A, 25-29, 1991.*





This was followed by examining bubble formation and movement as would happen when bubbles were formed everywhere on the bottom surface of an anode by forming the gas bubbles using a porous sheet through which air was passed. The effect of surface tension were also examined. Later, more realistic bubble formation was studied using electrolytically generated bubbles.

Bubble pattern under an anode at an equivalent current density of about 0.5 A/cm<sup>2</sup>. In water with anode inclination of about 1.0° (Left); about 3.0° (Centre); about 3.0° but with 0.4 vol% 1-propanol addition resulting in a reduction of surface tension from about 73 to 60mN/m(Right). (Chen, JOM, 15-20, November 1994.)

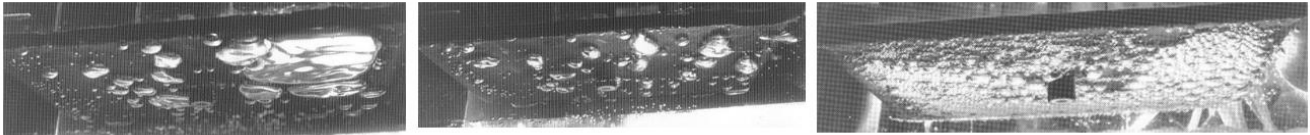

We also examined the behaviour of the electrolyte-metal interface, and the effects on the circulation in the electrolyte.



The gas-induced flow pattern in the anode/ledge space as obtained from 2-D air-water model(Left), the pumping action of the evacuation gas bubbles(Centre); and the resulting waves on the 'electrolyte-metal' interface(Right). (Chen, JOM, 15-20, November 1994.)

We have also built a semi-3-D model which allowed a more realistic representation. The following figure shows gas bubble evacuation and bubble burst in the anode-ledge space with wave and droplet formation at the 'electrolyte-metal' interface (Left), and 'metal' spout formation (Right).

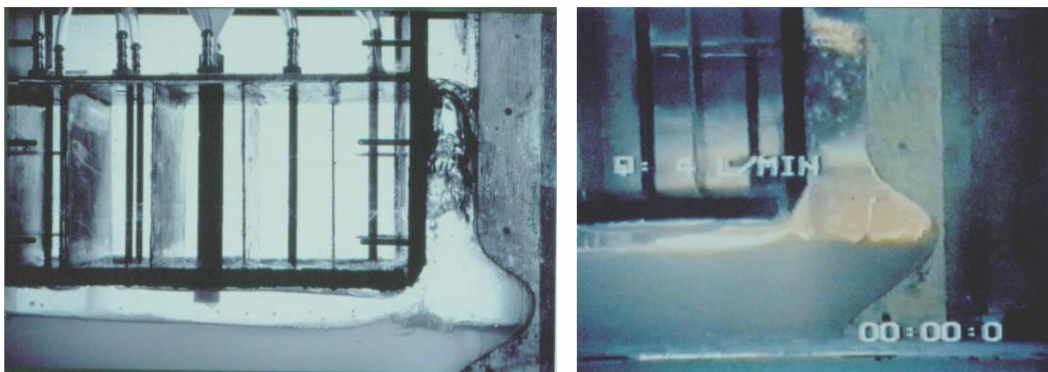

We then proceeded to build a 3-D full-scale model of an aluminium cell with the equivalent of 2 full anodes. The following figure shows two views of the 3-D full-



scale model, with then PhD student Marcus Walker(Left); Chuck Wei and Marcus Walker(Right).

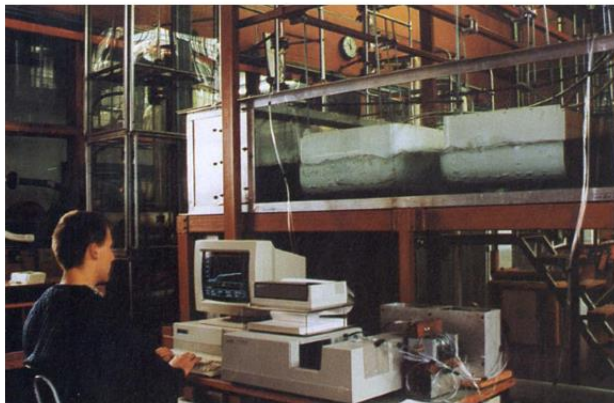

A number of different experiments were conducted using this rig including mixing(as this relates to the dissolution and distribution of the alumina feed, velocity distribution within the electrolyte, heat transfer on the side ledge, etc.

The following figure shows dye dispersion visualisation in a model aluminium cell viewed from the bottom, at different electrolyte bath depth. *Walker, PhD Thesis, Auckland, 1995*

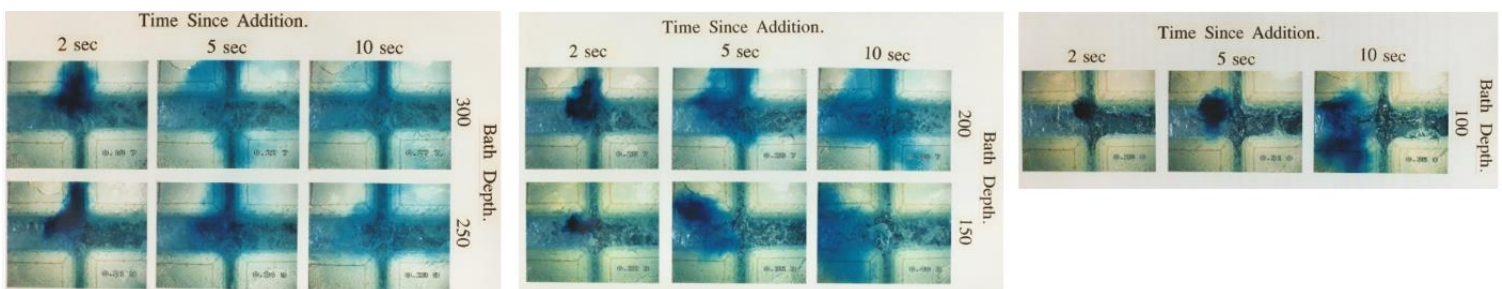

The following shows the measured electrolyte bath velocity distribution. (*Chen, Shen, Taylor & Welch, Light Metals(TMS), pp. 343-350, 1996.*)

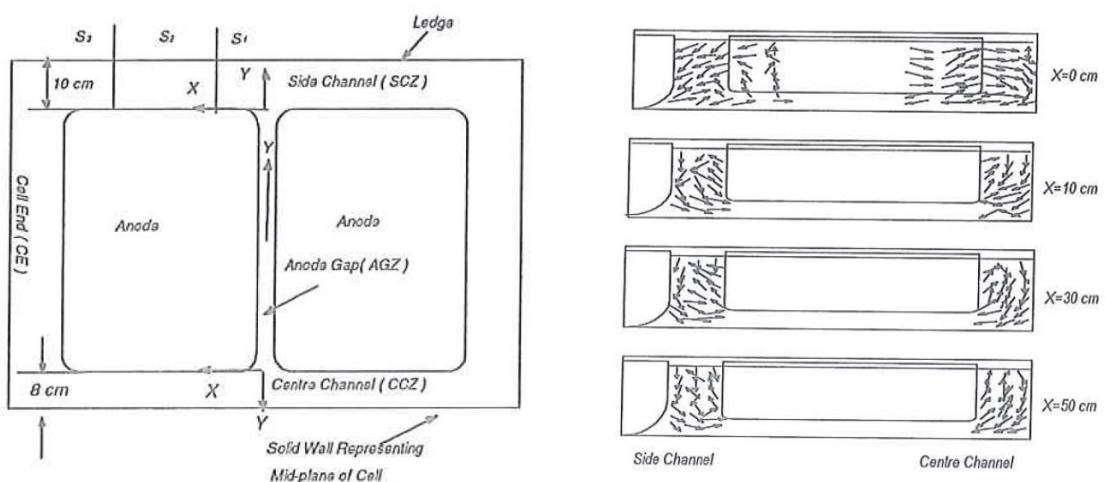

The following shows the set up for heat transfer coefficient measurement on the side ledge. (Chen, Wei, Ackland, *Light Metals(TMS)*, 357-364, 1996; Chen, Wei, Thomson, Welch & Taylor, *Light Metals(TMS)*, 285-293, 1994, Wei, Chen, Welch & Voller, *Light Metals(TMS)*, 309-316, 1997)

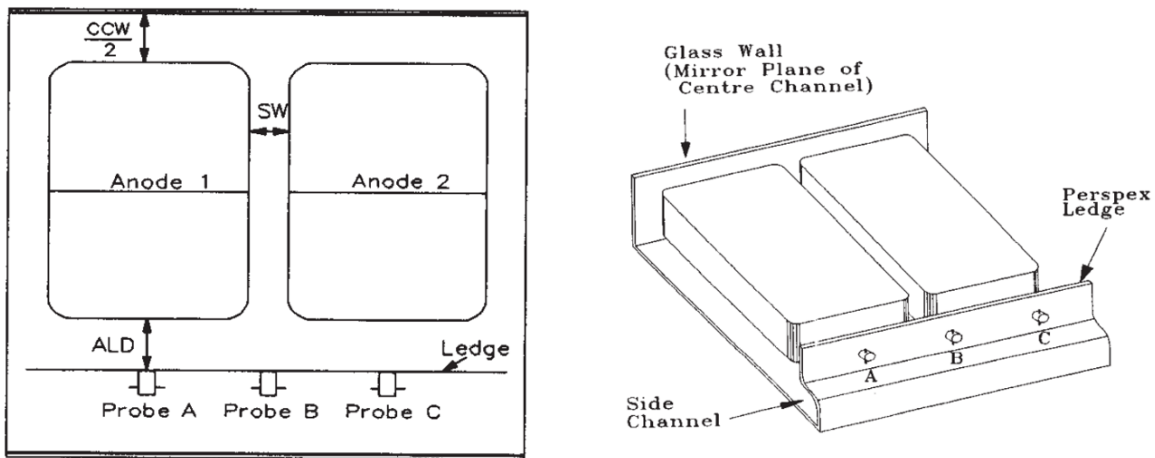

### Bubble Formation under anode anode

In addition to the air-water model for bubble formation on a downward facing anode, we also conducted tests using electrolytically generated bubbles using the following rig. An equivalent rig was also constructed for air-water experiments so that the two cases can be compared.

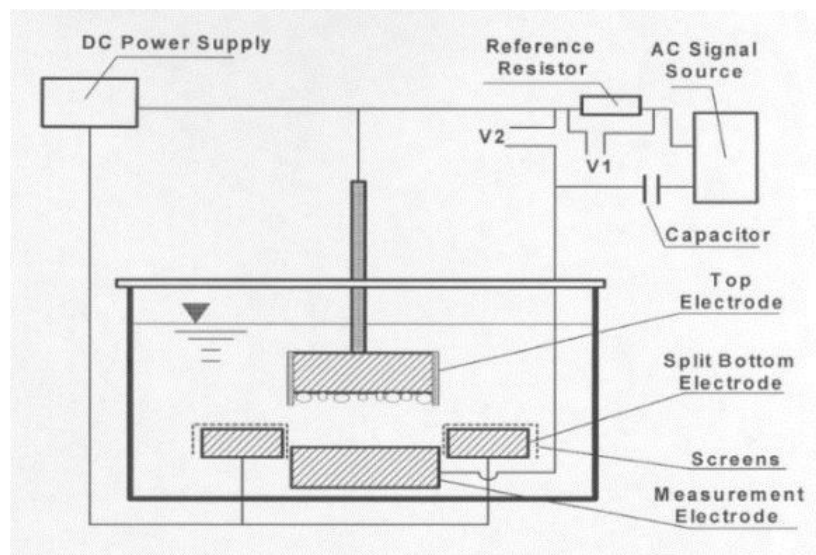



The following shows bubble patterns for the air-water situation(Left) and for bubbles generated electrolytically.

- Qian, Chen & Matheou, "Visual observation of bubbles at horizontal electrodes and resistance measurements on vertical electrodes" *J. Applied Electrochemistry*, 27, 434-440, 1997.
- Qian, Chen & Chen, "A study of bubble coverage and bubble resistance using cells with horizontal electrodes" *Journal of Applied Electrochemistry*, 28, 1141-1145, 1998
- Cooksey, Chen & Taylor, "Resistance due to gas bubbles in aluminium reduction cells", *JOM(TMS)*, 60, 51-57, 2008.

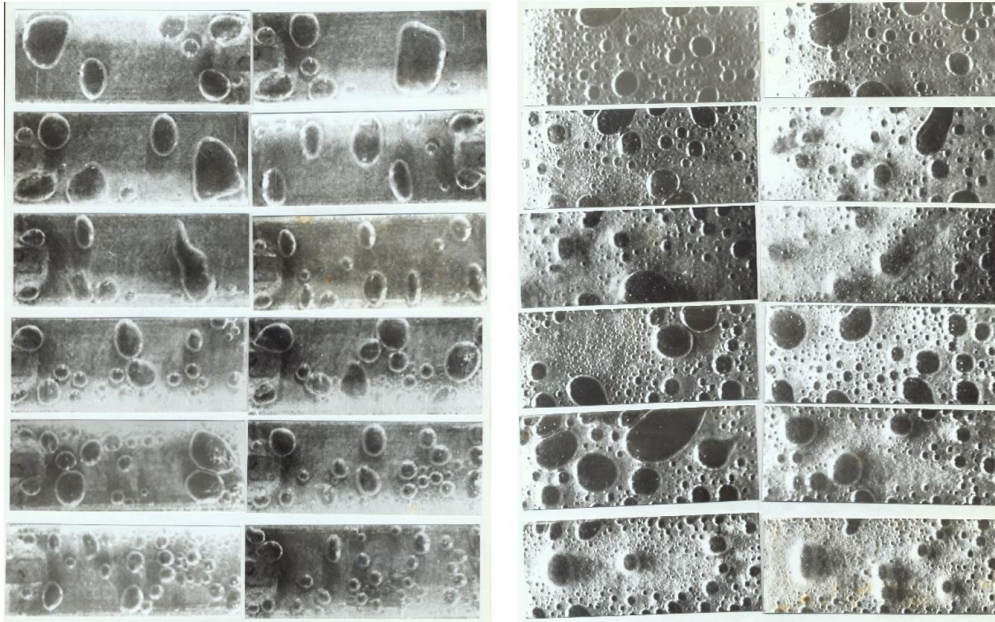

Further work was conducted using a grooved electrode, a graphite electrode and a carbon electrode.

Electrode Angle(°)	Grooved Electrode	Graphite Electrode	Carbon Electrode
2			
4			
6			
8			

- Chen, Qian & Zhao, Resistance in an electrolytic cell due to the presence of bubbles with a grooved anode *Trans. IChem E., Volume 79, Part A, 383-388, May 2001. (Invited paper, but fully peer-reviewed, for a Special Issue in Honour of Professor G.F. Hewitt, FRS, President IChemE 1989, and Honorary Editor, Trans IChemE, 1984-1999.)*

## Liquid-Liquid-Solid Interfacial Behaviour

The following figure (Left) shows schematically a typical shape of the side ledge of an aluminium cell, with the thinnest point at the position where the electrolyte-metal interface meets the ledge. When a metal rod is dipped in the cell in order to determine the depths of the metal and electrolyte layers (Right), there is also a region of high 'wear' at the level of the metal-electrolyte interface.

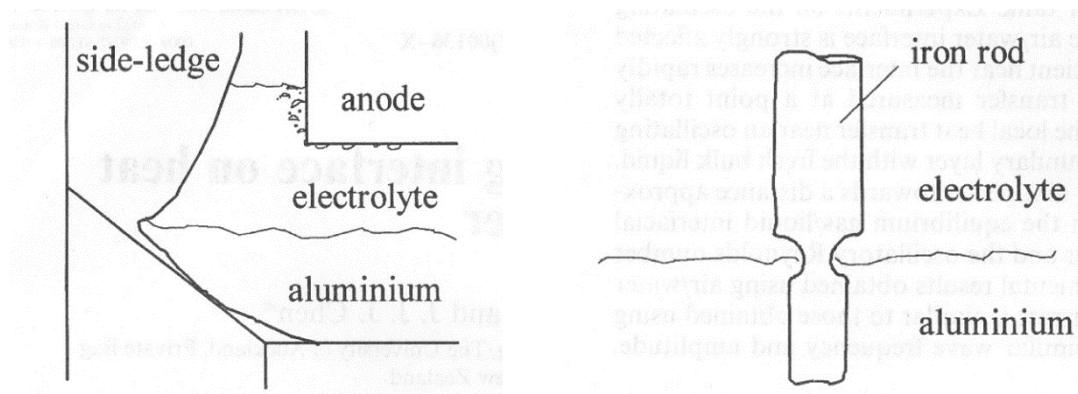

In an attempt to better understand the mechanism causing what is shown above, we first started with an ice model as shown below. The ice-water-oil model shows the 'erosion' effect when the electrolyte and the metal layers were simply stirred using a stirrer (Left). When waves were formed on the electrolyte-metal interface, the wear pattern is as shown on the Right.



- *Ligonesche, Chen, Gaillard, Homsy & Chen, Ledge shape modelling using a 2D wax-water model, Proc 6<sup>th</sup> Al Smelting Workshop, 585-592, 1998.*

To further elucidate the mechanism, we devised a simple experiment to measure the heat transfer rate, and the flow mechanism, when an interface is forced to oscillate. With the heat transfer experiments, the results were explained using the '**surface renewal**' model, based on the flow field as shown in the following diagrams.

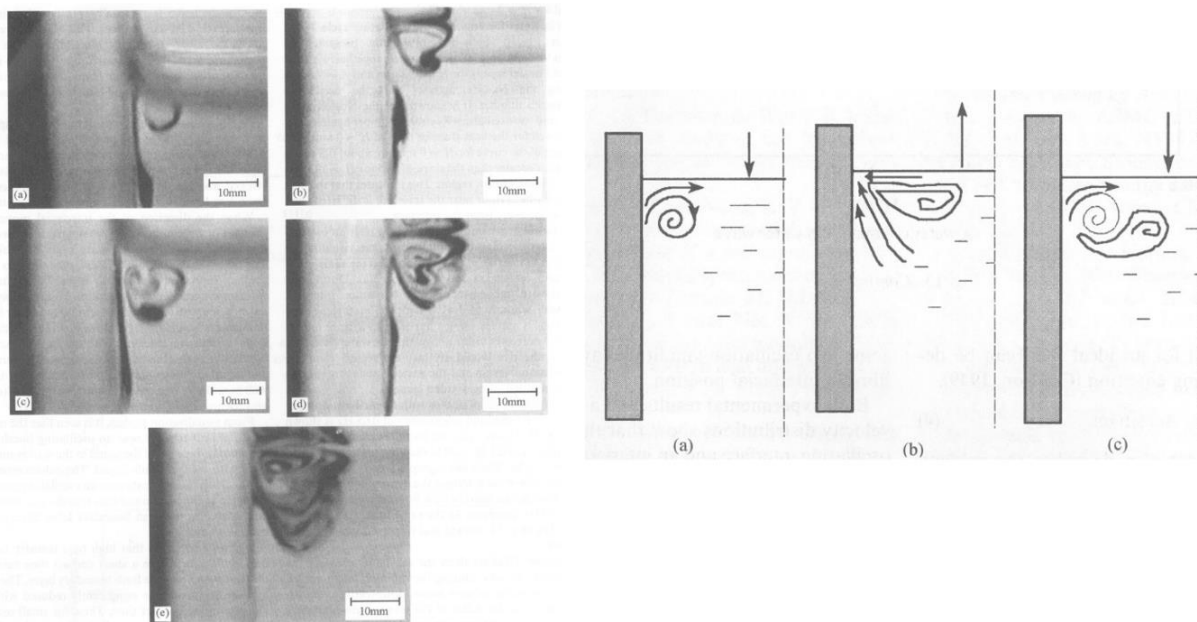

Details analysis maybe found in the following references and it has been shown that about the region near an oscillating interface, the transfer rate is significantly enhanced, The '**surface renewal**' concept was used in the analysis:

- *Chen, Chen & Chen, "Effects of an oscillating interface on heat transfer" Chemical Engineering Science, 52, 3265-3275, 1997.*
- *Chen & Chen, "A simple analysis of heat transfer near an oscillating interface" Chemical Engineering Science, 53, 947-950, 1998.*
- *Chen & Chen, "Local heat transfer for oscillatory flow in the presence of a single baffle within a channel", Chemical Engineering Science, 53, 3177-3180, 1998.*
- *Chen & Chen, "Liquid-solid mass transfer from a wall in contact with a gas/liquid interface undergoing wave motion" Metall.and Matls Trans., 29B, 563-567, 1998.*
- *Chen, Chen & Chen, "Vortex formation near the gas/liquid/solid boundary of an oscillating liquid column", J. Flow Visualisation and Image Processing, 52, 3265-3271, 1998.*

## Hydrogen diffusion anode

With support from CSIRO, we conducted exploratory research into the use of a Nickel-based hydrogen diffusion anode, with some promise, but clearly, it is still a very long way from being commercially viable.

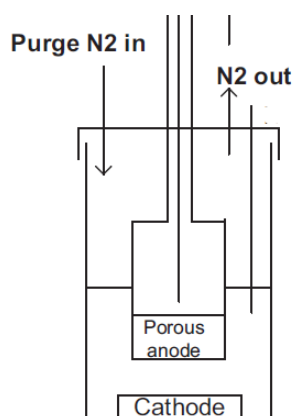

Electrolysis Cell



- Namboothiri, Taylor, Chen, Hyland & Cooksey, *An Experimental Study of Aluminium Electrowinning Using a Nickel-Based Hydrogen Diffusion Anode*, *Electrochimica Acta*, Vol. 56, 3192-3202, 2011. (This work was supported by CSIRO)
- Namboothiri, Taylor, Chen, Hyland & Cooksey, *Aluminium production options with a focus on the use of a hydrogen anode: A review*, *Asian-Pacific Journal of Chemical Engineering*, 2, 442-447, 2007.

## Aluminium smelting, Control, data analysis, decision making

Based on a granted patent by Taylor & Chen, Process Control of an Industrial Plant, US Patent 9,678,502 B2(June 13, 2017), work is in progress in developing a comprehensive smelter operation, control and management supervisory process control system which is designed to address a wide range of smelter management issues, provide early detection of abnormalities, improved smelter efficiency, reduction of emissions, increase pot lifetimes, and optimise staff performance and utilisation(McIntosh, Agbenyegah & Metson(2015).

## Data Analysis, Control Ellipse, Hotelling T<sup>2</sup> Statistic, Decision Making

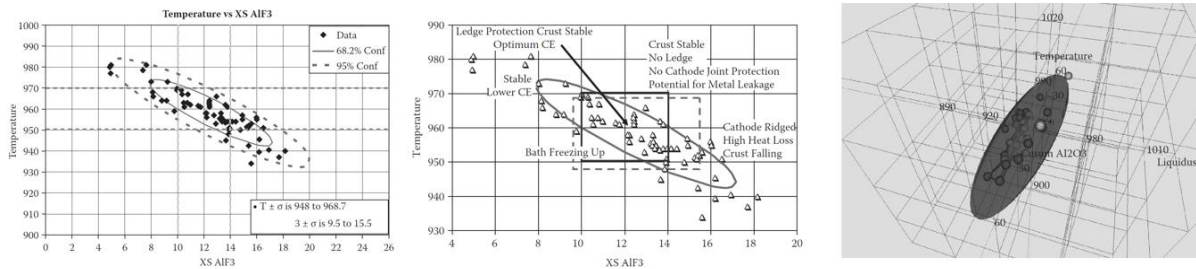

The control of excess aluminium fluoride and cell temperature was typically based on the graph(Left) with independent limits on XS AIF3 and Temperature. However, we found that the data behaviour is better explained by considering the Hotelling T<sup>2</sup> statistic which is represented by the ellipse. Thus, many cells were, in the past, either over-controlled or under-control(Centre). A 3D control ellipsoid for the alumina feed, the electrolyte liquidus temperature, and the cell temperature(Right). We have also applied multivariable analysis including the use of Principal Component Analysis.

- Taylor, Chen & Young, *Control for Aluminium Production and Other Processing Industries*, Chapter 12, p. 181-200, CRC Press, 2014.
- Chen & Taylor, *Control of Temperature and Aluminium Fluoride in Aluminium Reduction* *Aluminium*, Intl. Journal of Industry, Research and Applications, Vol. 81, (7/8), 678-682, 2005.
- Taylor & Chen, *Manufacturing Control for Aluminium Smelters*. *APT Aluminium – Process & Product Technology*, Vol. 2, Issue 1, 44-52, 2005.
- Taylor & Chen, *Advances in Process Control for Aluminium Smelters*, *Materials and Manufacturing Processes*, 22, 947-957, 2007; Gao, Gustafsson, Taylor & Chen, *The control ellipse as a decision making support tool to control temperature and aluminium fluoride in aluminium reduction*, 9th Australasian Aluminium Smelting Technology Conference and Workshop, 4-9 November 2007.
- Chen & Taylor, *Control of Temperature and Aluminium Fluoride in Aluminium Reduction*, *Aluminium*, Intl. Journal of Industry, Research and Applications, Vol. 81, (7/8), 678-682, 2005.)

By collaborating with a psychologist, we have also carried out work on improving decision making with the consideration of human factors.

- Taylor, Chen & Young, *Control for Aluminium Production and Other Processing Industries*, Chapter 11, CRC Press, 2014.
- 
- Gao, Taylor, Chen & Hautus, *Human Factors in Operational and Control Decision Making in Aluminium Smelters*, *Light Metals*, 605-609, 2011.
- Gao, Taylor, Chen & Hautus, *How to avoid the 'Invisible Gorilla' in aluminium smelting process control? Part I: Visual Guidelines*, *JOM*, 120-126, August 2011)
- Gao, Taylor, Chen & Hautus, *Operational decision making in aluminium smelters*, *Lecture notes in Artificial Intelligence*, 5639, pp. 167-178, 2009.
- Taylor, Mulder, Hautus, Chen & Stam, *Analysis of human work decisions in an aluminium smelters*, *Int. J. Decision Sciences, Risk and Management*, 2, 46-65, 2010.

We have also conducted work on safety, improving the control of smelting cells, and the interpretation of production cells experimental test data.

- Taylor, Chen & Young, *Control for Aluminium Production and Other Processing Industries*, Chapter 4, CRC Press, 2014.
- Hughes, Titchener, Chen & Taylor, *Pseudoresistance entropy as an approach to diagnostics and control in aluminium production*, *Asia-Pacific Journal of Chemical Engineering*, 2, 355-361.
- Chen & Taylor, *Analysis of smelting cell experimental trial data*, *JOM (TMS)*, Vol. 64, (2), 302-308, 2012.)
- Tandon, Taylor, Chen, *A case study of variation in aluminium smelting cell thermal state, with control implications*, *Metal. & Matls. Trans. 38B*, 707-712, 2007.

## Heat Exchanger & Grid Electricity

The following quote is from McIntosh, Agbenyegah & Metson(2015)

*LMRC is also involved in the development and commercialisation of technologies within the centre and with partner companies. One example is Shell Heat Exchanger(SHE) technology, currently undergoing extended performance trials on a group of pots in an operating smelter in Germany. Originally designed for efficient air-driven cooling of the reduction cell sidewall, essential for operation at increased amperage and metal production, it is now also being trialled for heat retention during periods of decreased amperage to allow stable operation while accommodating deep power modulation.*

The work was based on patents granted by Taylor, Chen et al., US Patent 8,778,257 B2(July 15, 2014) and US Patent 7,901,617 B2(March 8, 2011).

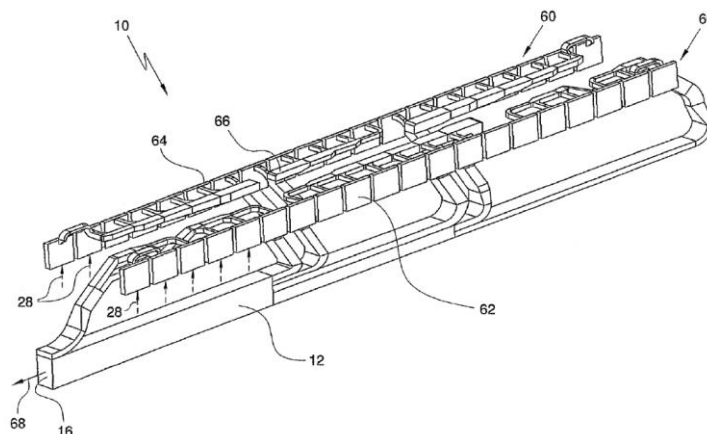

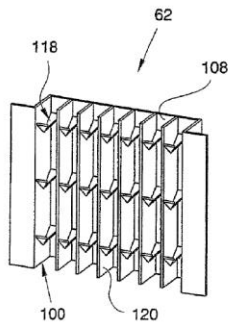

Fig.25

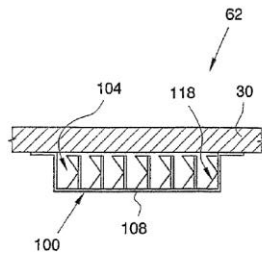

Fig.26

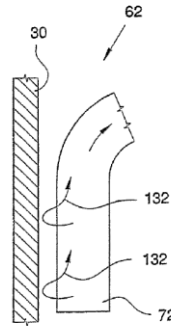

Fig.29

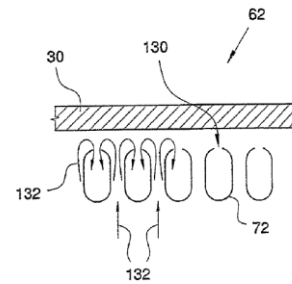

Fig.30

Also based on the above patent, making use of its insulation and heat removal mode, we proposed a method of operating an aluminium smelters at up to 20% above and 30-40% below the nameplate electricity usage allowing "flexible use of electricity, i.e. when consumer demand for electricity is high, smelters could take less energy from the grid. Conversely, during periods of low or no consumer demand, smelters could increase their production by up to 20%".

- Taylor & Chen, *Technique for Low Amperage Potline Operation for Electricity Grid Storage*, Metallurgical and Materials Transactions E, Vol 2E, 87-98, March 2015.
- Taylor & Chen, *Energy balanced*, The Chemical Engineer-ICHEME, Issue 891, 52-54, September 2015.
- Lavoie, Namboothiri, Dorreen, Chen, Zeigler & Taylor, *Increasing the power modulation window of aluminium smelter pots with shell heat exchanger technology*, Light Metals(TMS), 369-374, 2011.

## Molten aluminium metal treatment

The following shows a typical circuit in aluminium processing. We were commissioned to carry out research on the degasser.

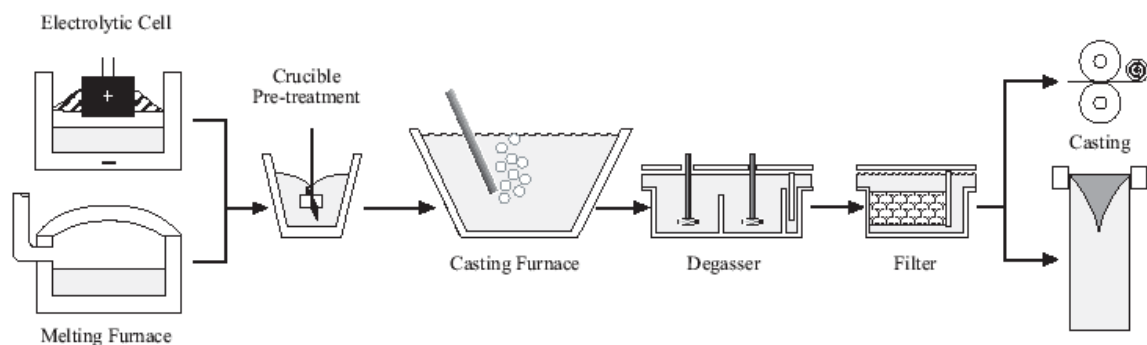

We built a full scale model of a typical degasser and conducted work on the bubble flow pattern, mixing, inclusion and degassing efficiency, etc.

- Zhao & Chen, "Effects of bubble and particle size distributions on the inclusion particle removal efficiency from molten aluminium by flotation", CHEMECA 97 Proceedings, Paper MP5b, Rotorua, October 1997.
- Ackland, Chen, Boontanjai and Grandfield "An analysis of inclusion removal from molten aluminium by gas sparging CHEMECA 90, 938-945, Auckland, August 27-30, 1990.)
- Chen, Feng & Hegna, "Gas-liquid flow pattern transition phenomena in a scaled model of an aluminium degassing tank" IPENZ Conference, Dunedin, 362-367, 9-13 Feb 1996. This paper received the IPENZ Skellerup Award 1996.



## Iron making melter (New Zealand Steel)

The following is a schematic of the Iron-making process at NZ Steel at Glenbrook showing the multi-hearth furnace, the rotary kiln and the melter (Left); a schematic diagram showing the cross-section of the melter (Right). The melter, of which there are two, converts the reduced Primary Concentrate and Char(RPCC), discharged by the rotary kiln, to molten iron. We carried out work on the melter in order to understand the mixing process that occurs inside the melter as well as well as exploring why the freezing occurs in the lower part of the melter.

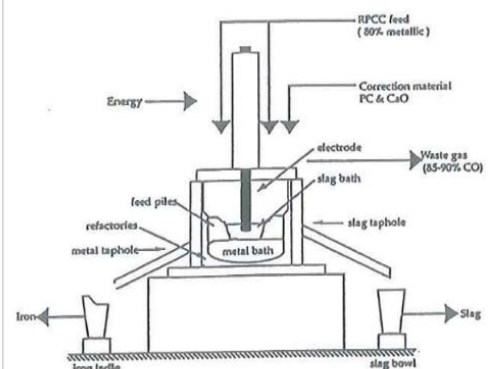
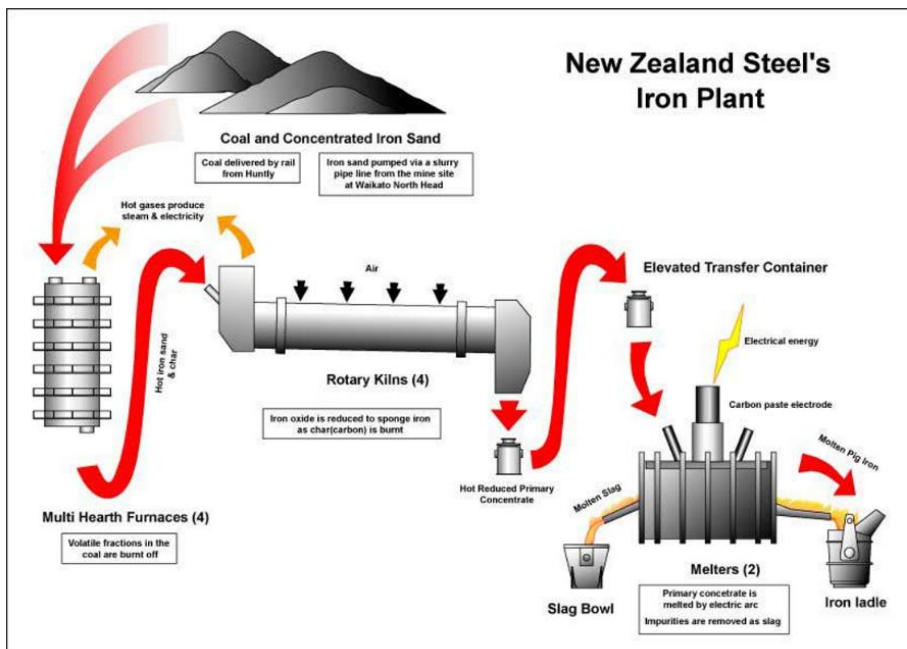

We built an scaled oil-water model of the melter as shown in the following diagram(Left) and carried out velocity measurements within the model. It is interesting that a 'gull-wing' pattern(Right) is clearly visible because of changes of the refractive index of the liquid with temperature. From this observation and the velocity measurements, it is clear that the gas evolved around the electrode was insufficient to cause effective mixing in the liquid thus causing severe temperature stratification which contribute to freezing of the lower part of the melters.



- *Chen, Ye, Winters, Rogers, Gregory & Garlick "A model study of the BHP New Zealand Steel iron-making melter", PACRIM Congress(AusIMM), Auckland, pp. 113-117, 19-22 November 1995.*

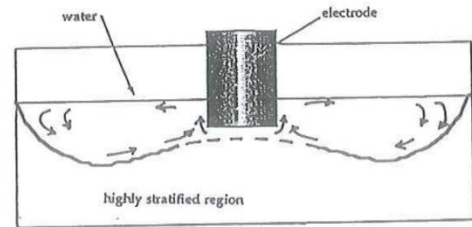
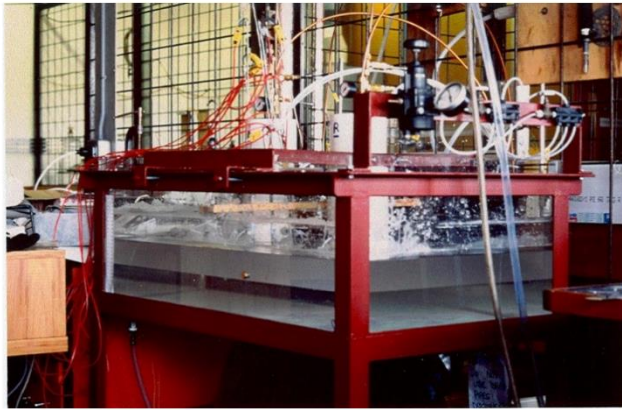

## The New Zealand Steel Co. Tundish in the steel-making process

The following (Left) shows the NZ Steel Co.'s steel-making circuit with the vanadium recovery unit, the KOBM steel converter, transfer ladle taking the steel produced to the slab casting machine from which the molten steel flows into a tundish before casting (Left); Water model of the tundish (Right) which was used to conduct residence time distribution(RTD) measurements using a tracer and the impulse response method.

- *van Noort T.M., Chen J.J.J., Magusin J., Reindler S. and Mathieson J.G., "Water model study of a slab casting tundish", CHEMECA 90, 215-222, Auckland, August 27-30, 1990*
- *Chen J.J.J., Gregory O., Leggett A.R., Mathieson J.G. & Williams G.K., "Study of a tundish using a 1/3-scale water model", Proceedings of the 78th Steelmaking Conference (Iron & Steel Society), 163-164, Nashville, 2-5 April 1995. Full paper in 1995 Steelmaking Conference Proceedings, pp. 593-598.)*

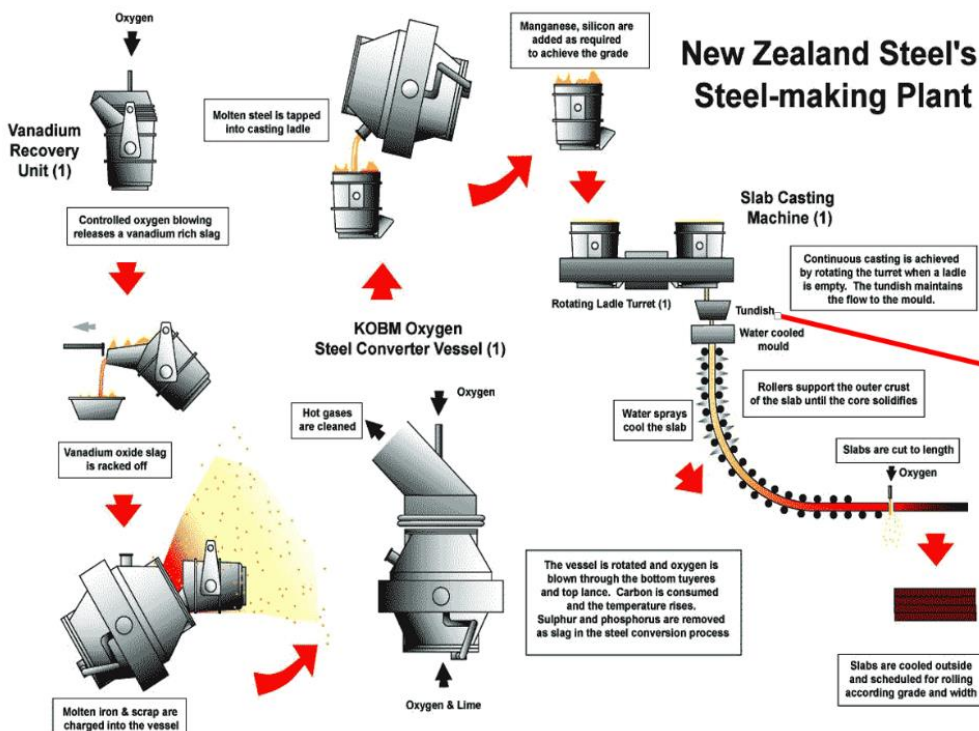

The following shows details of the tundish (Left), and dye-trace experiment showing the flow velocity front (Right).

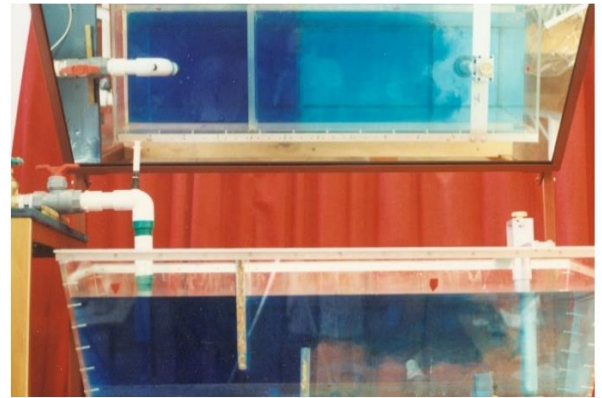
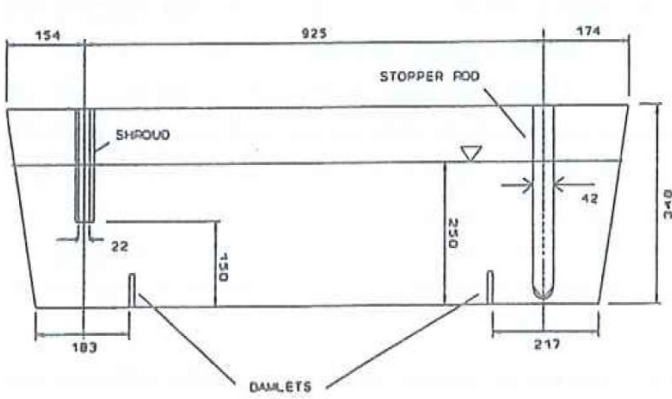

## Annealing furnace heat transfer model

Using a 3D finite element model for a continuous steel annealing furnace, the temperature distribution in the furnace and the steel strip were studied in order to obtain important operational control parameters for use in production situation enabling optimised furnace operating methods and improved product quality

- Depree, Chen, Taylor, Sneyd, Taylor & Wang, Development of a three-dimensional heat transfer model for continuous annealing of steel strip, *Ind. Eng. Chem. Res.*, Vol. 51, 1790-1795, 2012.

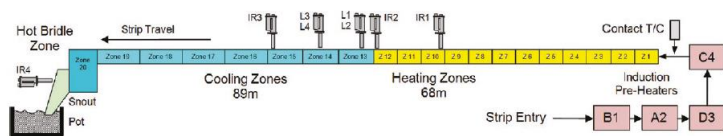

Figure 1. Furnace schematic diagram showing location of Pyrometers IR1–4 and L1–L4, Induction Pre-Heaters B1–C4, and Contact Thermocouple.



Figure 2. View inside furnace heating zones.

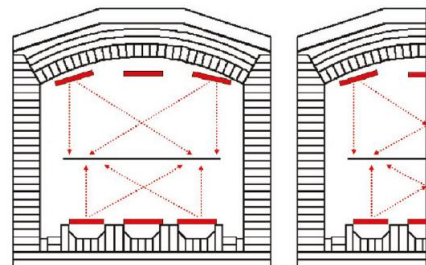

Figure 3. "Mirror wall" along furnace plane of symmetry maintains radiative heat transfer inside furnace cavity.

## Concluding Remarks

I have presented this lecture in three sections.

### Section I:

- I gave an account of my personal encounters with Emeritus Professor Miles Kennedy and also highlighted some of his research work.

### Section II:

- A brief comparison of the formation of the Canterbury and the Auckland Departments and some details about the Auckland programme.
- A brief discussion on C&M graduates
- Research in the Auckland Department, its strength and performance.
- Under 'History and Connections', some background of the first I.Chem.E. accreditation of the Canterbury and the Auckland degrees were discussed and the dates confirmed.
- The achievements of Professor Titchener were discussed based on a paper by Professor Kennedy.

### **Section III:**

- I gave a brief perspective of some of process metallurgy research carried out in Auckland, but dealing only with those that I was associated with.

### **Acknowledgements**

- I am most grateful to Emeritus Professor A.M. Kennedy who kindly provided information, read a draft of my lecture, and made comments and suggestions.
- Professor Mark Taylor, collaborator since the late 1980s and co-author of much of the work covered in Section III, for comments and suggestions.
- Emeritus Professor W.G. Ferguson for much of the details about the C&M Department, comments and suggestions.
- Professors Ashvin Thambyah, Brent Young and Rob Kirkpatrick for providing information, comments, and suggestions.
- Peter Slane and staff at IChemE(Rugby) for obtaining the information on accreditation.
- I thank the IChemE-NZ Board for the invitation to present this lecture.

### **References**

(This list contains references cited in Section I & II. Those cited in Section III associated with my work are given within the text)

Crookes, Samuel Irwin(1871-1955), <https://www.engineeringnz.org/our-work/heritage/engineering-hall-fame/samuel-irwin-crookes-18711955/> (accessed 6 May 2019)

Danckwerts, P.V. and Kennedy, A.M. (1954a), Kinetics of liquid-film process in gas absorption. Part I: Models of the absorption process, *TransIChemE*, 32(Supplement): S49-S52, 1954. Republished in *Chem. Eng. Res. & Dev.*, V75(Supplementary), S101-S104, December 1997. Also in "Insights into Chemical Engineering, Selected papers of PV Danckwerts", 1981, 76-79.

Danckwerts, P.V. and Kennedy, A.M. (1954b), Kinetics of liquid-film process in gas absorption. Part II: Measurements of transient absorption rates, *TransIChemE*, 32, S53-S59. Also in "Insights into Chemical Engineering", 1981, 109-117. Also in "Insights into Chemical Engineering, Selected papers of PV Danckwerts", 1981, 80-86.

Danckwerts, P.V. and A.M. Kennedy, A.M. (1958), The kinetics of absorption of carbon dioxide into neutral and alkaline solutions, *Chemical Engineering Science*, V8, 201-215. Also in "Insights into Chemical Engineering, Selected papers of PV Danckwerts", 1981, 87-100.

Danckwerts, P.V., Kennedy, A.M., Roberts, D. (1963), Kinetics of CO<sub>2</sub> absorption in alkaline solutions—II. Absorption in a packed column and tests of surface-renewal models, *Chemical Engineering Science*, V18, 63-72. Also in "Insights into Chemical Engineering, Selected papers of PV Danckwerts", 1981, 109-117.

Denham, H.G. (1924), The Chemical Engineer, Lecture given before the Canterbury College Engineering Society on 3 May 1924, reproduced in R.B. Keey, Progress and Practice in Chemical and Process Engineering, pp. 7-10, 1994.

Dobbie, T.(2018), Where did I go wrong, Kennedy-Wunsch 2018 Lecture.

Donnan, F.G., Prof. H.G. Denham, Nature, 152, 529-530, 1943

Fail, P. (2014), A chemical engineer's role in design, operation, project management, consulting and governance, Kennedy-Wunsch 2014 Lecture.

Ferguson, W.G., (2017), Presentation at Chemmat Gold 1967-2017, Auckland Chemical & Materials Engineering Department 50<sup>th</sup> Anniversary Celebration, 17 February 2017.

Jones, M. (2013), The Responsibility of being a Chemical Engineer, Kennedy-Wunsch Lecture, 2013.

Kennedy, A.M. (1974), Amateurism or Professionalism in Chemistry, 5-11, Chemistry in New Zealand, February 1975.

Kennedy, A.M. (1981), Nothing should ever be done for the first time (Presidential address, NZIE Conference, Auckland, 9 February 1981), New Zealand Engineering, 50-59, April 1, 1981.

Kennedy, A.M., (1994), Engineering, education and energy: Some contributions of Alan Lee Titchener, Trans. Institution of Professional Engineers New Zealand, Vol 21, No 1/GEN, pp. 23-26, July 1994.

Kennedy, A.M. (2010), Early days of chemical engineering in New Zealand, Inaugural Kennedy-Wunsch Lecture, 2010.

Kennedy, A.M. (2015), Reflections by Dr Miles Kennedy-Alumni Corner, CEB Focus, p. 19-20, Issue 15, Easter 2015. ([www.ceb.cam.ac.uk](http://www.ceb.cam.ac.uk)). <https://www.ceb.cam.ac.uk/news/ceb-focus/cebfocus15-2015/cebfocus15> (Accessed 7 May 2019)

Kennedy, A.M. (2019) Personal Communications, emails to John Chen, 4, 5 April; 1, 5, 6 May 2019.

Marshall, K. (2011), A Chemical Engineer in the Primary Industries, Kennedy-Wunsch 2011 Lecture.

McEldowney, L. (Editor), (1980), Challenges faced by NZIE in 1980, New Zealand Engineering, pp. 9, 11-13, 1980.

McIntosh, G.J., Agbenyegah, G.E.K., & Metson, J.B.,(2015) Alumina microstructure and its properties as an adsorbate: an example of research at the Light Metals Research Centre, Chemistry in New Zealand, pp 36-41, January 2015

Packer, J.E.(2019), Personal correspondence, email to John Chen, 8 May 2019.

Pollard, J., (1994), The prehistory of the Department of Chemical Engineering, in R.B. Keey, Progress and Practice in Chemical and Process Engineering, pp. 11-30, 1994.

Robinson, K., (2013), The bigger picture-reinventing engineering education, **tce**, (The Chemical Engineer-ICHEM), 32-35, October 2013.

Slane, P. (2019), Personal communication, email to John Chen, cc. Merv Jones, George Ferguson, Ken Morison, 30 April 2019.

Thambyah, A. (2019) Personal communication, Current research in C&M, May 2019.

UniNews, (2013), University of Auckland news for staff, V43, Issue 8, 17 October 2013.

Varey, P. (2012), Life on the edge-Peter Danckwerts GC, MBE, FRS, brave, shy, brilliant", PFV Publications, ISBN 978-0953844012.

Williamson, A.G. (1994), 50<sup>th</sup> Jubilee of Department of Chemical and Process Engineering at the University of Canterbury, 4-6 MAY, 1994, Chemistry in New Zealand, Vol 58, No 3, p. 4, May 1994.

Wunsch, Donald Frederick Sandys(1887-1973), The Encyclopedia of New Zealand, <https://teara.govt.nz/en/biographies/4w28/Wunsch-donald-frederick-sandys> (Accessed 29 April 2019)