

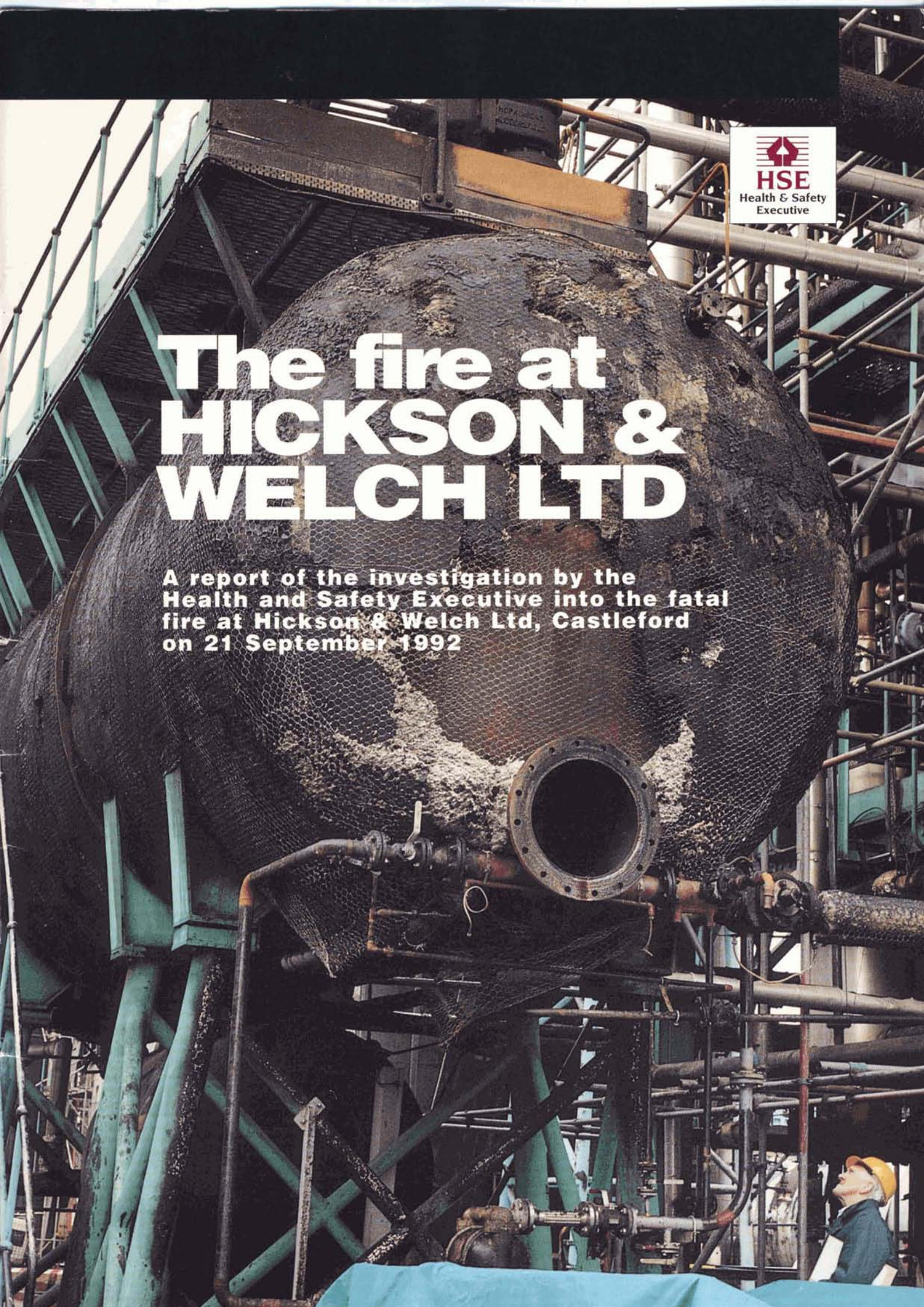

The fire at **HICKSON & WELCH LTD**

A report of the investigation by the
Health and Safety Executive into the fatal
fire at Hickson & Welch Ltd, Castleford
on 21 September 1992





The fire at HICKSON & WELCH LTD

**A report of the investigation by the
Health and Safety Executive into the fatal fire
at Hickson & Welch Ltd, Castleford
on 21 September 1992**

© Crown copyright 1994

Applications for reproduction should be made to HMSO

First published 1994

ISBN 0 7176 0702 X

CONTENTS

SUMMARY	<i>1</i>
THE COMPANY AND SITE	<i>3</i>
PLANT AND PROCESS	<i>4</i>
Nitrotoluenes and the Meissner plant	<i>4</i>
The separation process	<i>4</i>
Chemical hazards	<i>7</i>
60 still base	<i>7</i>
Build up of residue in 60 still base	<i>8</i>
THE INCIDENT	<i>11</i>
Preceding events	<i>11</i>
Ignition and fire	<i>12</i>
THE EMERGENCY	<i>13</i>
DAMAGE AND INJURIES	<i>14</i>
INVESTIGATION AND FINDINGS	<i>16</i>
HSE investigation	<i>16</i>
Findings	<i>21</i>
Coroner's inquest	<i>22</i>
LEGAL PROCEEDINGS	<i>23</i>
MANAGEMENT AND SAFETY SYSTEMS	<i>24</i>
Management structure	<i>24</i>
Management of the Meissner plant	<i>24</i>
Health and safety management	<i>25</i>

Permit to work procedures	<i>26</i>
HEALTH AND SAFETY LEGISLATION	<i>26</i>
HSE AND HICKSON & WELCH LTD	<i>28</i>
CONCLUSIONS AND LESSONS TO BE LEARNED	<i>29</i>
Conclusions about prevention arrangements	<i>29</i>
Action by the company	<i>31</i>
Lessons	<i>31</i>
REFERENCES	<i>34</i>
APPENDICES	<i>35</i>
1 Plan of the factory and immediate surroundings	<i>36</i>
2 Plan of the Meissner control building showing extent of fire damage	<i>38</i>
3 Plan of the 2nd floor of the main office block	<i>40</i>
4 Three-dimensional drawing of the smoke route through protected route C	<i>42</i>

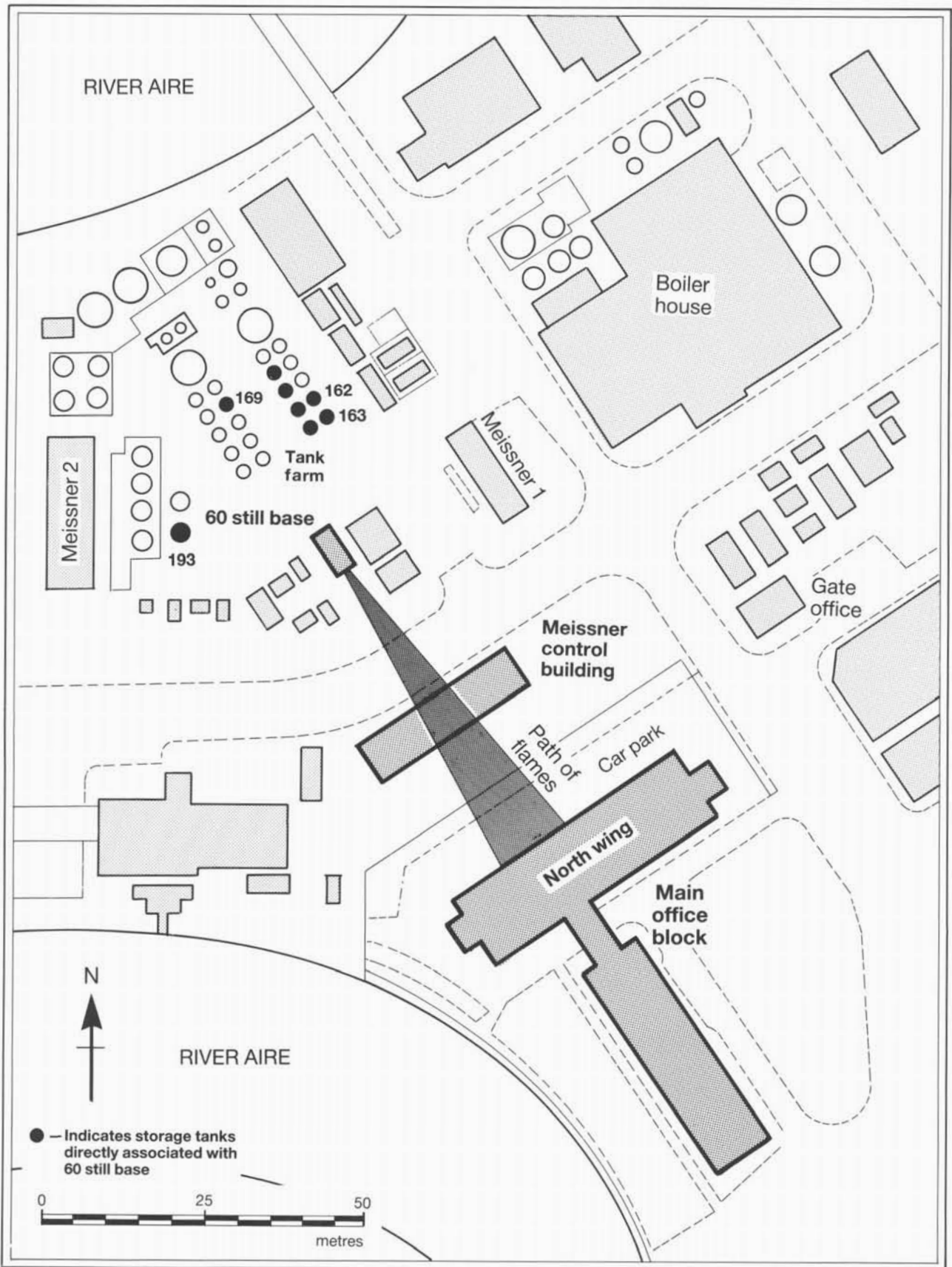

Figure 1 Plan of area around 60 still base showing path of the jet of flame

SUMMARY

- 1 At approximately 1.20 pm on 21 September 1992 a jet of flame erupted from a manway (access opening - see front cover and Figure 7) on the side of a batch still at the factory of Hickson & Welch Ltd, Wheldon Road, Castleford, West Yorkshire. The flame cut through an office/control building nearby killing two employees, David Wilby and George Potter, instantly. Three other employees in these offices sustained severe burns but escaped. Two later died in hospital (Neil Gafney and John Hopson).
- 2 The flame also struck a much larger four-storey office block, shattering windows and setting rooms on fire. There were 63 employees in this building including a number who were returning from lunch. All managed to escape with the exception of a young employee, Sara Atkinson, who was overcome by smoke in a second floor toilet. Although she was rescued by fire service personnel approximately 40 minutes later, she died on 23 September 1992 from the effects of smoke inhalation.
- 3 At the time of the incident a process vessel known as '60 still base', used to distil an organic liquid in batches, was being raked out to remove an accumulation of semi-solid residue or sludge which was rich in dinitrotoluenes and nitro cresols. Before raking, heat was applied for about three hours to the residues through an internal steam coil. This started a self-heating (exothermic) runaway reaction in the residue leading, with disastrous consequences, to deflagration and a jet flame.
- 4 The incident could have been prevented if the hazards and the risks associated with this non-routine clean-out operation had been accurately assessed beforehand and suitable precautions taken. However, fundamental errors and incorrect assumptions were made, which led to an incident in which five people lost their lives. The incident also revealed defects in fire precautions affecting the means of escape from parts of the main office block.
- 5 In view of the nature of the incident, and public concern, the Health and Safety Commission instructed the Health and Safety Executive (HSE) to carry out a formal investigation under Section 14(2)(a) of the Health and Safety at Work etc Act 1974 and make a special report. For the sake of brevity this report concentrates on the cause of the incident and the precautions that should have been taken to prevent it but omits reference to many perfectly satisfactory arrangements identified during the investigation.
- 6 Following the investigation by HSE, Hickson & Welch Ltd was prosecuted. The company was convicted for an offence under Section 2 of the Health and Safety at Work etc Act 1974 at Leeds Crown Court on 30 July 1993 and was fined £250 000 with £150 000 in costs awarded against it.
- 7 The investigation revealed several important lessons some of which are of general relevance to the chemical industry. These are summarised below and can also be found at the end of this report.

LESSONS ARISING

Lesson 1

Where the batch distillation of highly energetic materials (such as mononitrotoluenes or other organic nitro compounds) is carried out still residues should be analysed, monitored and removed at regular intervals to prevent possible build up of unstable impurities.

Lesson 2

The use of chemical plant for a different process or purpose should be treated as a plant change procedure requiring rigorous assessment. Consequently before plant is used to carry out non-routine operations authorisation should be obtained from an appropriate level of management who should ensure that plant hazards have been identified, risks assessed and the precautions determined.

Lesson 3

Safe systems of work covering all aspects of operation and maintenance of all process plant should be established and defined in comprehensive instructions including those operations undertaken at infrequent intervals. These systems should be monitored by management and reviewed at appropriate intervals.

Lesson 4

The nature, operation and limitations of control systems on process plant should be determined, and their implications for health and safety taken into account, before non-routine operations requiring their use are authorised.

Lesson 5

Companies should assess and monitor the workload and other implications of restructuring levels of management and supervision to ensure that key personnel have adequate resources, including time and cover, to discharge their responsibilities.

Lesson 6

Persons authorised to issue permits to work should be sufficiently knowledgeable about the hazards associated with relevant plant. If 'authorised' personnel are relocated to former workstations refresher training should be given and recorded before re-authorisation.

Lesson 7

The design and location of control and other buildings near chemical plant which processes significant quantities of flammable and/or toxic substances should be based on the assessment of the potential for fire and explosion and/or toxic releases at these plants. Companies should assess the suitability of existing control buildings and if they are found to be vulnerable reasonably practicable mitigating action should be taken.

Lesson 8

Companies should regularly monitor and audit their own compliance with performance standards defined in their fire certificates. Particular attention should be paid to the effects of material alterations, eg installation of pipework and cable ducts and other work in areas concealed by false ceilings, to ensure that the fire-resisting integrity of protected routes is maintained and fire training records should be regularly updated.

Lesson 9

When exercising their on-site emergency plans companies should ensure that roll call information on missing persons is passed immediately, accurately and directly to the Senior Fire Officer in charge. Roll call procedures should be practised routinely to ensure that they are effective when carried out at all periods of the working day.

THE COMPANY AND SITE

- 8 Hickson & Welch Ltd is part of the Fine Chemicals Division of Hickson International plc and the factory was first established at its present site in 1915. The company employs approximately 900 people manufacturing organic chemicals; it has specialised for many years in the production of aromatic compounds including nitrotoluenes.
- 9 The factory occupies a site on the edge of Castleford which covers 66 hectares (163 acres). It is less than 0.5 km from the town centre and the factory is split by the River Aire and adjoins the Aire and Calder Canal (see map - Appendix 1). Land to the north of the site is mostly open ground but elsewhere and nearby there is a sports stadium, a number of large factories and a significant amount of housing.
- 10 A section of the site called the 'nitrotoluenes area' is dedicated to the manufacture of nitrotoluenes which is carried out continuously in plants called Meissner I and II. The Meissner plants, auxiliary plant and associated storages faced the north wing of the main office block. Between them was a car park and a control building used by managers and operatives on the Meissner plant (Figure 1).

PLANT AND PROCESS

Nitrotoluenes and the Meissner plant

- 11 The nitration of toluene to produce mononitrotoluene (MNT) is achieved by reacting toluene, under controlled conditions, with mixed acid (a mixture of 96% nitric acid and 80% sulphuric acid). The reaction produces three forms or isomers of MNT known as *ortho*-nitrotoluene (oNT), *meta*-nitrotoluene (mNT) and *para*-nitrotoluene (pNT) and by-products including dinitrotoluenes (DNT) and nitrocresols. Originally, Hickson & Welch Ltd produced MNT using a batch processor. In 1962 however the company installed its first continuous processor using a system developed by Meissner in West Germany.
- 12 The production capacity of the first plant (Meissner I) was 20 tonnes per day but in 1972 Hickson & Welch Ltd commissioned a second plant, Meissner II, with a capacity of 60 tonnes per day.
- 13 Product from the continuous nitrators contains MNT isomers and by-products which requires treatment and separation. Originally, product from the Meissner plants was first washed with water to remove residual nitric acid. Nitrocresols were removed at a second caustic wash stage as soluble sodium cresylate. Excess caustic was removed by further water washing before distillation. The cresylate was then treated before discharge as effluent.
- 14 In 1988, however, the caustic wash procedure for removal of nitrocresols was stopped for environmental and safety reasons. Concern had been raised about nitrocresols in effluent discharge to the local river. A number of alternative methods for nitrocresol removal were considered before the system described below was adopted.

The separation process

- 15 At the time of the incident MNT isomers (oNT, mNT and pNT) were separated from each other and from DNT and nitrocresols via a complex sequence of distillations and crystallisations which have been summarised in a simplified flow diagram (Figure 2).
- 16 The first distillations in two fractionating columns removed oNT, unreacted toluene and water. The bottom liquors from the second column were rich in pNT and they were passed through box crystallisers where the pNT crystallised to leave a liquor that was called '60% whizzer oil'. This liquor was collected and distilled through the second or similar fractionating columns to remove a mixture rich in oNT and mNT. Bottom liquors leaving that were rich in pNT. They were passed through box crystallisers to remove the pNT leaving a liquor known as '40% whizzer oil'. This material was kept in a number of large vertical storage tanks (see Figure 4) ready for distillation in 60 still base.
- 17 The successive distillations and crystallisations raised the concentration of the less volatile DNT and nitrocresols from circa 0.5% and 0.7% respectively to 14% and 19%, in 40% whizzer oil. The final separation involved batch distillation of this material in 60 still base to recover more MNT.

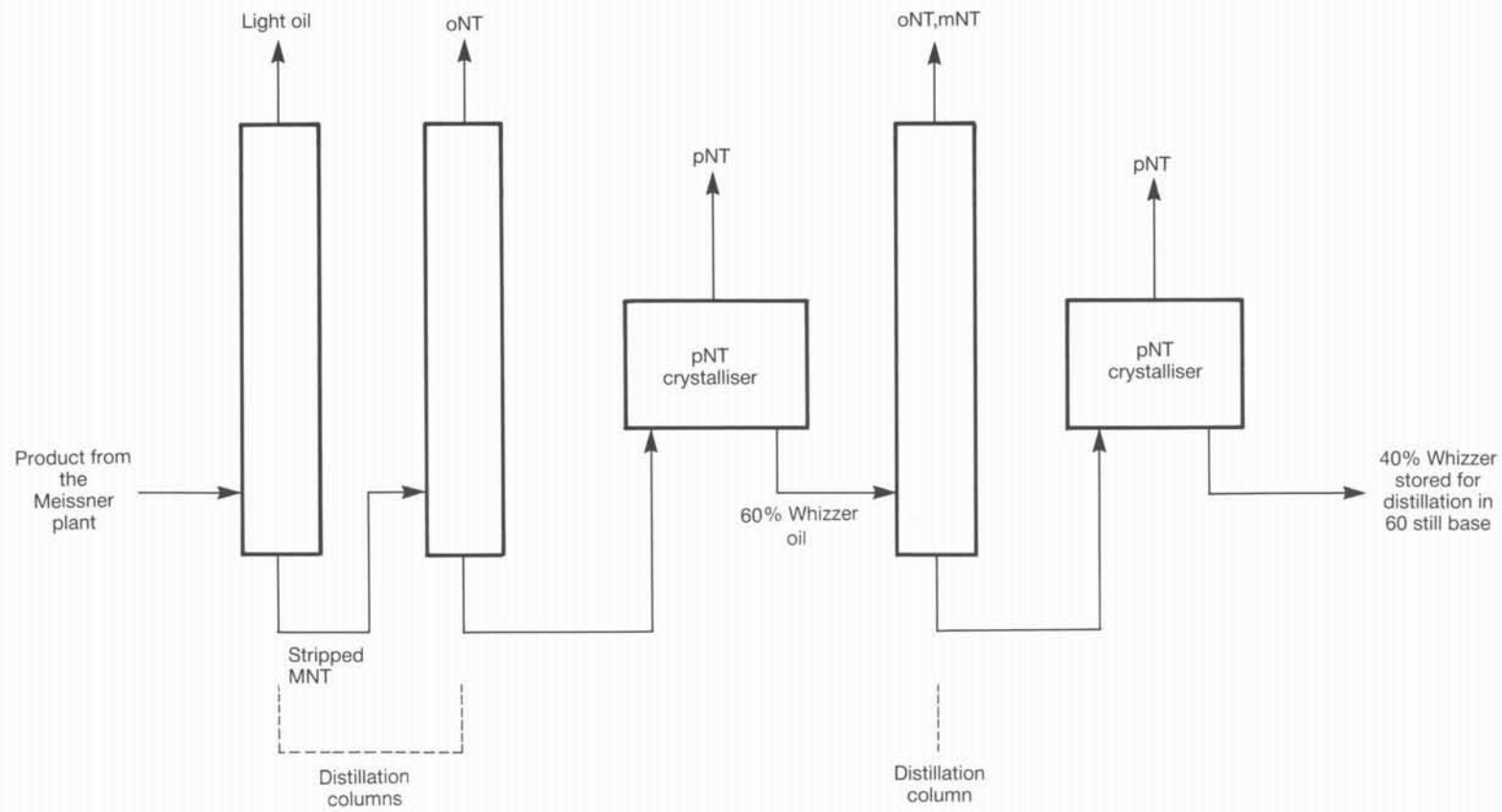

Figure 2 Simplified flow diagram of the MNT separation

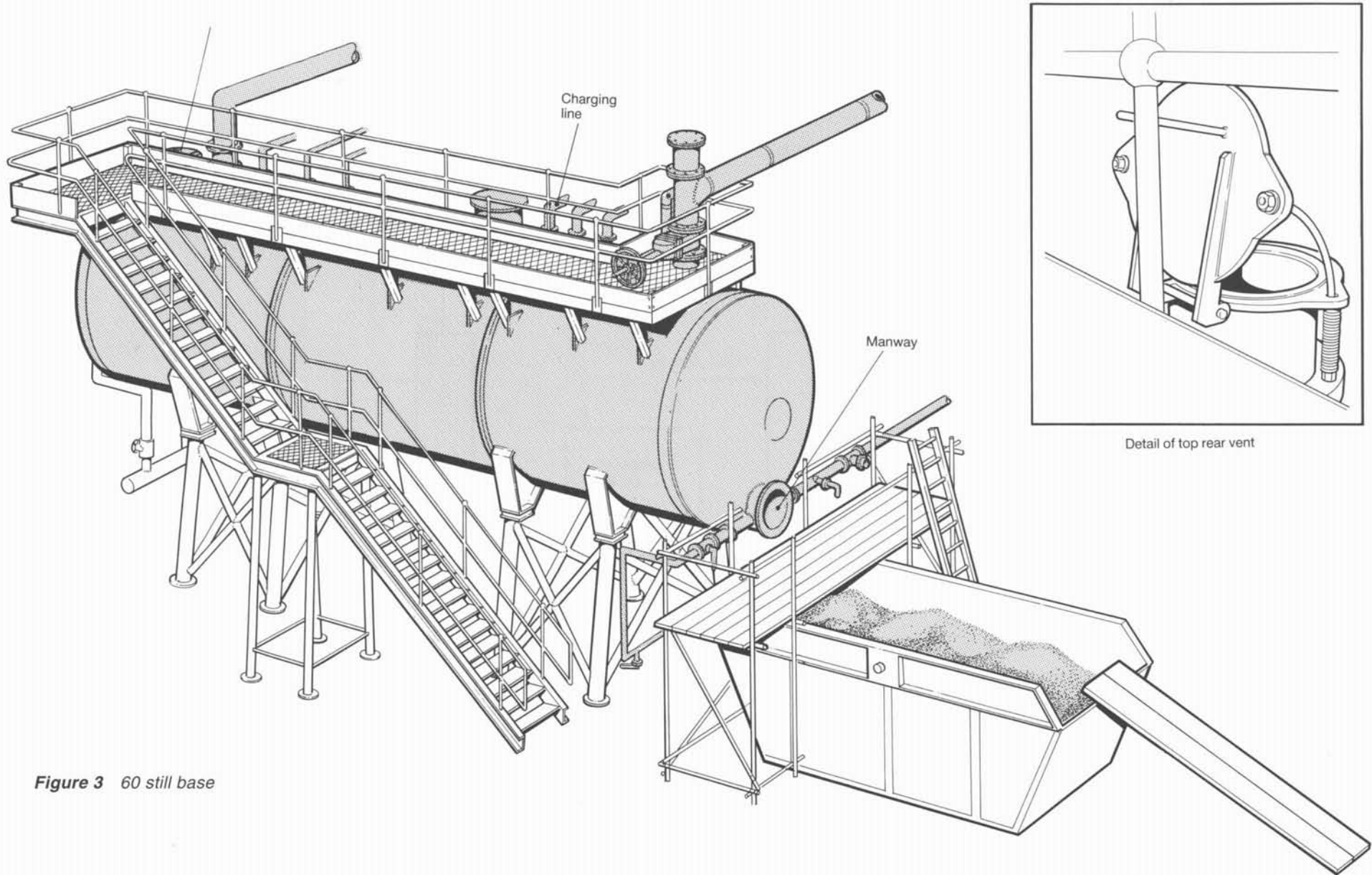

Figure 3 60 still base

Chemical hazards

- 18 The isomers of mononitrotoluene (oNT, mNT and pNT), which were separated by distillation and crystallisation, are toxic substances. Two of these isomers (oNT and mNT) are liquid at room temperature; pNT is a solid. The other principal by-products of the mononitration process, ie, DNT and nitrocresols, are energetic and toxic. It is well known in the chemical industry that all of these organic nitro compounds can be explosive in the presence of strong alkali or strong acid. However, heating alone has been sufficient to trigger explosions because these substances become increasingly unstable when heated to high temperatures or when they are held at moderate temperatures for long periods^{1,2,3}.
- 19 These hazards were well known to senior management at Hickson & Welch Ltd. Previous incidents at the factory confirmed these characteristics. Specialists in the company had developed a system of thermal stability testing to provide plant managers with information necessary for safe operation of distillation plant. The company reviewed these test procedures in 1984 and more recently in 1988 and 1989, when batch distillation in 60 still base was introduced to remove DNT and nitrocresols from 40% whizzer oil.

60 still base

- 20 60 still base was a 45 500 litre horizontal, mild steel, cylindrical tank 7.9 m long and 2.7 m in diameter. It stood on iron tube legs 2.9 m off the ground (Figures 3 and 4). The tank sloped slightly towards the front to allow discharge through an off-take line mounted at the base of the front face manway. The off-take pipe was attached to a pump which transferred run-off at the end of distillation to storage tank 193 (Figure 4).
- 21 Plans for the vessel showed that it had been installed in the nitrotoluenes area in 1961. It had been used from that date for batch distillation and heating was provided in the vessel through three steam battery coils, mounted horizontally at the rear of the tank. They had internal support and extended through the still base approximately two thirds of its length. The lower battery was 230 mm above the tank bottom. The other two batteries were 430 mm above the lower coil (Figure 5).
- 22 Steam to the batteries came through a reducing valve off a main that supplied steam at 27.6 bar (400 psig). A regulator should have controlled steam to the batteries at 6.9 bar (100 psig). However, the regulator was defective and plant operators compensated for this by controlling steam through the main isolating valve. This was opened until steam was seen whispering from a relief valve on the battery steam supply line. The relief valve was set at 100 psig but was found to be operating at 135 psig (9 bar). At this pressure steam in the battery tubes would have been at about 180°C.
- 23 Towards the rear and top of the still base was a spring-loaded pressure relief vent flap through which plant operators took samples for thermal analysis. They could also measure the level of liquid and depth of the semi-solid residue through this opening with

a rod that passed through the steam coils to the bottom of the still base. At the front of the tank was a circular manway covered by a 460 mm diameter lid which weighed approximately 60 kg. The manlid was secured, during normal operation, by 16 nuts and bolts.

- 24 Distillation of 40% whizzer oil in 60 still base was done in 'pairs', under vacuum. The first 'fresh' distillation was started with the still base notionally empty and it was charged to a depth of 2.16 m (85 in) corresponding to a volume of 42 770 litres. The level was checked through the rear vent using a metal cross suspended from a chain. The horizontal of the cross corresponded to a depth of 2.16 m (Figure 4). After charging, operatives took samples of the batch for thermal analysis and if satisfactory results came back from the laboratory, distillation was started. Laboratory results allowed plant managers to calculate how far the distillation could proceed. Typically, distillation was stopped when a 1:1 ratio of volatiles (MNT) to involatiles (DNT and nitrocresols) was achieved. The plant managers' decisions were based on the percentage of residue in the samples taken and the degree to which these residues self-heated (exothermed) on test equipment.
- 25 After the first distillation was complete heating was stopped. The liquid remaining was allowed to cool below 100°C and vacuum was relieved. At this point a 'top up' charge of 40% whizzer oil was added to the still base. Sampling and thermal analysis were repeated and again, if the results were satisfactory, distillation proceeded until the 1:1 ratio of volatiles to involatiles was achieved. After the 'top up' distillation the material left in 60 still base was allowed to cool before transfer to tank 193 from where it was removed by road tanker as 'hazardous waste' for disposal by incineration off site.

Build up of residue in 60 still base

- 26 Since it was first installed in the nitrotoluenes area, in 1961, 60 still base had never been opened for cleaning. Following the process change in 1988, manufacturing problems affecting quality and production were experienced in the nitrotoluenes area. The continuous stills were stripped and cleaned to remove residues and operators working on 60 still base began to notice and reported a build up of sludge in this vessel which was slowing the rate of distillation. Various estimates were made about the depth of sludge but the general consensus was that there was as much as 1820 litres equivalent to a uniform depth of about 10 cm (4 in). A senior employee had reported a depth of 29 cm (12 in) several months before the incident and on 21 September 1992, the day of the accident, the same employee dipped the still base on the instructions of his area manager. He used a metal dipping rod and estimated that the sludge was approximately 34 cm (14 in) deep.
- 27 After the incident management at the factory offered another theory to explain why this depth of sludge had accumulated. They suggested that ordinarily the sludge level in the still base ebbed and flowed leaving about 1820 litres in the still base between successive distillations. However, the company claimed that the higher than expected level noted on 21 September was attributable to material removed from whizzer oil storage tanks

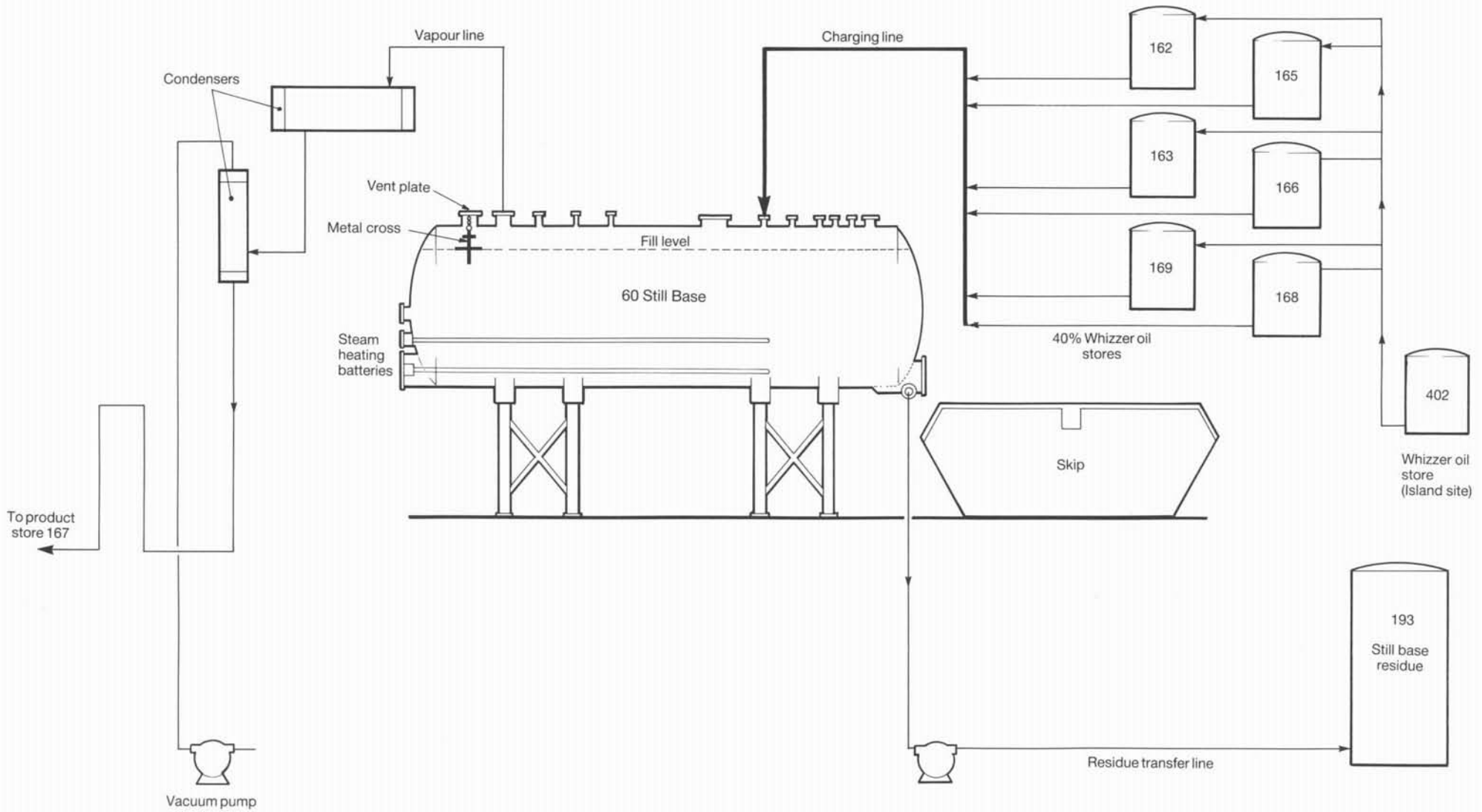

Figure 4 Schematic diagram of 60 still base and associated plant (including metal cross fill level device)

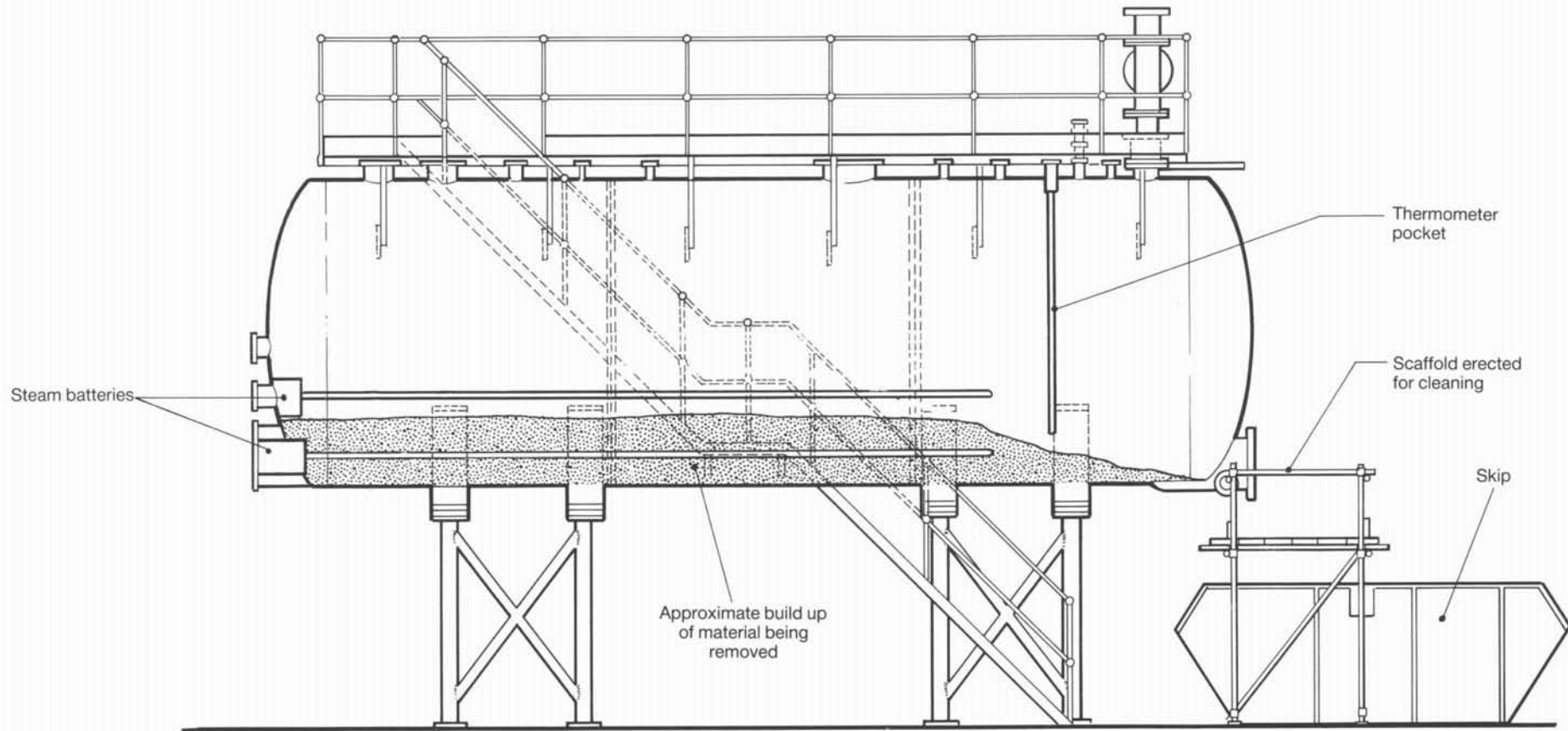

Figure 5 Longitudinal section of 60 still base showing estimated sludge accumulation and position of the thermometer pocket

162 and 163 on 10 September 1992. On that occasion 60 still base was used as a 'vacuum cleaner' to suck out sludge left in 162 and 163 stores which were being cleaned out for a different product. The vacuum cleaning operation resulted in transfer of what the company estimated to be 3640 litres of a jelly-like material. It had been the intention of those employees involved in this operation to pump this material directly to 193 store, but transfer was slow and not completed because the material was thick. A fresh charge (batch number 107) for a new distillation was therefore put into 60 still base on top of the remaining contents. Distillation proceeded normally and was followed by a 'top up' distillation (batch 108) which finished on 19 September 1993. The still base was then allowed to cool before the remaining liquid was pumped to 193 store on 20 September. The decision to clean out 60 still base followed discussion between the area manager and one of the site shift managers three days before.

THE INCIDENT

Preceding events

- 28 The removal of residue from 60 still base was discussed by a shift manager and the area manager (AM) on Thursday 17 September 1993 (paragraph 27). The shift manager had been told by employees that the vessel had never been cleaned out. He realised that the bottom steam battery was covered by sludge and he advised the AM. They discussed preparation for the clean-out which required removal of steps and a platform in front of the vessel and provision of a scaffold and skip so that the sludge could be removed from the front face manway (Figures 4 and 7).
- 29 The AM gave instructions that preparation should be made over the weekend: however, when he got to work at 8 am on Monday 21 September nothing had been done. After the sludge had been dipped (paragraph 26) the AM had to decide whether the job should proceed. The whizzer oil storages were full and it was necessary to keep the still base operational. The AM was assured by team leaders, however, that preparations could be made quickly to minimise down time. Immediate arrangements were made to provide a scaffold and skip which were in place by 10.15 am.
- 30 At 9.45 am the AM instructed that steam should be applied to the bottom battery to soften the sludge. Advice was given that the temperature inside the still base should not exceed 90°C. This was recorded by an employee on a piece of paper which was found in the Meissner panel room after the incident. However the thermometer probe was above the level in the sludge and was, in fact, recording the temperature of the atmosphere just inside the manway (Figure 5). Even if it had been in the sludge it would not have adequately monitored the temperature variation across the vessel, but might have given warning that the temperature was much higher than anticipated.
- 31 At 10.15 am the team leader made out a work request and permit for a fitter to remove the manlid (paragraph 86). The fitter arrived to sign on for the job at 11.10 am and shortly afterwards he went for lunch. At this stage the AM was concerned about delay

and operatives who were standing by to remove the sludge volunteered to take off the manlid. This was authorised by the same team leader who made out another permit.

- 32 It took approximately half an hour to remove the manlid and then the AM asked the employee who had previously dipped the sludge to examine it. This was done using a piece of aluminium cladding as a scoop to remove material from just inside the manway. The AM was told that the material was gritty with the consistency of soft butter. The AM did not however check for himself: he mistakenly thought that the material was thermally stable tar and no instructions were given for it to be analysed or for the atmosphere to be checked inside the vessel for flammable vapour.
- 33 The raking out operation started immediately. Two process technicians, observed by a trainee, used a welded iron rake found on the ground nearby. The rake was 2.5 m long with a narrow solid head and it was used for approximately 1 hour to remove a 2 m section of sludge from just inside the manway. The material was tar-like and had liquid entrained in it. At 12.50 pm the AM instructed that extensions should be made for the rake which was not long enough to reach the back of the still base. At about the same time the fitter came back from lunch and it was realised that the still base inlet had not been sealed. He was given a job note and permit to blank the infeed line (paragraph 86).
- 34 At this stage the vessel temperature gauge in the panel room read 48°C and the AM instructed that the bottom steam battery should be isolated. Steam was shut off by a senior operative who came on shift at 1.00 pm. This employee (one of the deceased) commented to a workmate about the metal rake. He suggested that wooden rakes might be more suitable and he mentioned specifically a previous incident (in 1973) when sparks from a metal pneumatic drill used in a still base had caused a fire. At 1.15 pm the AM left for lunch and two of the raking team, who were waiting for the rake extensions, left the still base to get on with other work. Five minutes later the jet of flame erupted.

Ignition and fire

- 35 At approximately 1.20 pm the operative left on the scaffold had stopped raking and was bending down level with the manway when he saw a blue light which turned instantly to an orange flame. As he leapt from the scaffold, towards the panel room, an incandescent conical jet erupted from the manway and was projected horizontally towards the Meissner control building. The fitter, who was blanking the still base inlet, saw a vertical jet shoot out of the top rear vent (Figure 3) to the height of the distillation column nearby (Figure 8). He jumped from the top of the still base stairway (approximately 5 m) and ran clear. Witnesses estimate that the jet lasted for approximately one minute before subsiding to localised fires around the manlid and buildings nearby. The force of the jet destroyed the scaffold and propelled the still base manlid which was on it into the centre of the Meissner control building. The jet severely damaged this building and then impacted on the north face of the main office block.

THE EMERGENCY

- 36 The roar of the flame was heard both on and off-site. Personnel in the gate office (Fig 1) saw the incident directly and sounded the on-site alarms at once. A '999' call was made immediately. A gate office employee requested assistance from the ambulance and fire services but only spoke directly to the ambulance service before the call was terminated at the exchange. Incoming calls then prevented further calls by this employee for assistance. The fire service and police received calls from members of the public and were at the scene within 5 minutes. Fire crews from Castleford, Pontefract and Normanton were met on arrival by the company's fire and safety officers. A total of 22 appliances and over 100 fire-fighters led by a Senior Divisional Officer attended.
- 37 The Hickson & Welch Ltd fire team responded immediately and they focused their efforts on the burning Meissner control building and the still base. Fire service personnel initially concentrated on fires in and search of the main office block.
- 38 At the time of the incident most of the main office personnel were at lunch. Some had returned, including a group of people who had assembled in the second floor sales office (Appendix 3). With the exception of one of the deceased all escaped via designated protected routes (paragraph 48) to an assembly area nearby, several minutes after the initiating event. At the assembly point at approximately 1.40 pm a number of employees reported that a colleague was missing to two managers who had organised a roll call. They were told the name of the missing person and probable location on the second floor. This information was passed on to fire service personnel.
- 39 The fire service officer in charge instructed the Pontefract and Normanton fire crews, on arrival, to commence a search of the main office block because he assumed that persons were missing inside. Search teams equipped with breathing apparatus went into the building immediately. Their search began at the ground floor and followed standard fire service procedures. Officers worked their way through and up the building and on the second floor, in the women's toilet on the north wing (Appendix 3), they found a young female employee who had been overcome by smoke. She was carried out of the building at 2.03 pm and was taken to Pinderfields Hospital in Wakefield by police helicopter. Other search teams with more detailed information about the missing employee had entered the office building shortly before she was brought out.
- 40 Fires in the north wing of the main office block and on site were brought quickly under control and by 4.00 pm the number of appliances on site was reduced to eight. An hour later this was further reduced to four.
- 41 The police log of the incident records their first incoming call at 1.22 pm, from a traffic warden. They immediately set up traffic control around the factory and at 1.40 pm they activated the joint company/police 'Ringwarn' system by which the police communicate warnings to designated schools and businesses in the immediate area. The procedure was introduced for incidents which could lead to off-site consequences. The police also contacted HSE, HM Pollution Inspectorate and the National Rivers Authority.

- 42 At 3.00 pm, after it became clear that two people had died at the scene, a Detective Chief Inspector (DCI) from West Yorkshire police and the Coroner's Officer arrived to take charge of police enquiries. The DCI summoned assistance from Home Office forensic scientists who arrived later in the afternoon. Contact was also made with inspectors from HSE as soon as they arrived at the scene.
- 43 The first casualties were picked up by the ambulance service at 1.46 pm and they were taken to the Accident & Emergency Unit at the General Infirmary in Pontefract. Burn victims were however sent to Pinderfields Hospital in Wakefield.

DAMAGE AND INJURIES

- 44 Most of the main fire damage was roughly in a V-shape emanating from the still base to an area where the flame hit the main office block 55 m away (Figure 1). However, there was some damage to scaffolding on the adjacent vertical still, caused by the jet which came out of the rear vent. The panel room beside the still base was scorched and windows were broken (Figure 8).
- 45 The central section of the lightly constructed Meissner control building took the initial impact. An area approximately 6 m wide was consumed and to either side there was extensive fire damage (Figure 9 and Appendix 2). At the rear of the centre section a metal control panel weighing 1040 kg was found on its side.
- 46 Behind the control building a section of palisade fence was demolished and a number of vehicles in the adjoining car park were gutted.
- 47 The exterior of the north wing of the four-storey main office building was scorched (see Figure 10). Brickwork in the centre of the fire damage zone was spalled, windows shattered and their frames melted. The most severe damage extended upwards to the second floor, immediately outside the big sales office, where employees were congregating after lunch. Flame and fire spread horizontally through the north facing offices but did not penetrate to the middle corridors which linked the means of escape (Appendix 3).
- 48 The means of escape had been defined in the fire certificate (serial number 15/03/3/77) issued to the company by HSE under the Fire Certificates (Special Premises) Regulations 1976 (see paragraph 94) as a set of performance standards to be achieved. These specified, inter alia, that within prescribed travel distances a 'protected route' ie a passageway or stairway enclosed with fire-resisting construction, would be available. Three such 'protected routes' (designated A, B and C) were specified in the fire certificate. Route C was a protected stairway from the third floor to the second floor and it discharged into the south wing via linking corridors. Fire doors also allowed access to the west and east ends of the north wing from protected route C to alternate routes A and B (see Appendix 3). The enclosure for protected route C, on the second floor, adjoined toilet accommodation for men and women. There were breaches in the fire resisting construction of protected route C, above the false ceiling, around pipes and cables which passed from the office where the

jet flame had impacted, through protected route C into the toilet accommodation. These breaches and the false ceiling provided a direct path for smoke into the women's toilet. Smoke damage in the women's toilet is shown in Figure 11 and it was here that an office worker was found. The probable direction of smoke travel is illustrated in Figure 12 and Appendix 4.

- 49 At the time of the incident five employees were working in the Meissner control building. Two who were located in the centre of the building (David Wilby and George Potter) were killed instantly. The others ran down the central corridor but their escape was impeded by the inward opening end door (Appendix 2). Due to the intense heat all received serious burns and were taken to hospital, where two later died from their injuries (Neil Gafney and John Hopson). The employee who was found in the main office block (Sara Atkinson) died later in hospital.
- 50 Two other employees sustained reportable injuries. The fitter working on top of the still base fractured his right heel and sprained his left ankle. The employee who observed the blue light in the still base sustained burns to his left leg. Fifteen other employees required treatment for minor injuries and shock. A contractor nearby was concussed when he fell and a fire-fighter was struck by falling debris in the main office building. Immediately after the incident the company engaged a consultant to provide stress counselling for those employees and others most deeply affected by the tragedy.
- 51 In the days that followed a large number of people became ill, displaying symptoms suggesting either toxic effects or infectious disorder. By the end of the first week three groups had been defined. One was the burn victims (three in all). The second group was hospital staff attending casualties, who developed toxic irritations affecting the skin and mucus membranes. The third and largest group, however, comprised fire-fighters who suffered gastro-intestinal symptoms or toxic effects. Nineteen fire-fighters were admitted to hospital and out of 181 reported cases of illness, 115 were studied jointly by the local health department, a consultant from National Poisons Unit and the Employment Medical Advisory Service.
- 52 This epidemiological study carried out by public health authorities concluded that there was a strong association between those displaying gastro-intestinal symptoms and the consumption of cold drinks by the fire service personnel at the incident site. A common viral infection was also diagnosed. With regard to the first and second groups, it was not possible despite thorough investigation to link their toxic irritations with any particular substance(s) which might have been released by the fire.
- 53 As a result of this inquiry the Public Health Department recommended that eating and drinking at the site of a chemical incident should be avoided but, if necessary, fire brigades should provide their own supplies of food and drink which should be consumed in safe areas subject to normal standards of food hygiene.
- 54 Although the company's 'Ringwarn' procedure was implemented this was a precaution (paragraph 41). There were no off-site effects. The local authority (Wakefield

Metropolitan District Council) arranged for collection and analysis of samples of vegetation from three sites in the vicinity. They were analysed for MNT and DNT isomers and none were found above relevant detection limits. The National Rivers Authority confirmed that the incident had not polluted local water courses. River quality downstream was checked and no adverse effects were found because fire-fighting water had been effectively contained by the firm's effluent system.

INVESTIGATION AND FINDINGS

HSE investigation

- 55 The HSE area office in Leeds was informed of the accident at 2.15 pm, 55 minutes after the fire. Notification came from the police, at the request of the firm whose phone lines were jammed. At 3.00 pm two inspectors arrived at the scene and contacted the senior police and fire officers present. It was soon apparent that a major fatal accident had occurred and information was sent back to the area office where the area director activated the area's major incident plan.
- 56 The area office then contacted technical specialists in HSE, HM Inspectorate of Pollution and the Environmental Health Department of Wakefield Metropolitan District Council. It was requested that the local authority should set up a team to assess off-site pollution.
- 57 The principal inspector, who co-ordinated the HSE inquiry, and a principal specialist inspector also went to the scene and following preliminary discussions with the DCI from West Yorkshire Police a statutory notice was served on the company under Section 20(2)(e) of the Health and Safety at Work etc Act 1974 requiring that the scene of the incident should be left undisturbed.
- 58 The following day 18 staff from HSE assembled at the factory. They included inspectors from the Leeds and Newcastle area offices, local specialist inspectors from the North East Field Consultant Group and experts from the Research and Laboratory Services Division (RLSD), and a photographer. The company provided facilities for HSE to set up an incident and interview rooms and four small investigation teams were established to:
 - (a) prepare a site damage report;
 - (b) examine the still base and its associated plant;
 - (c) collect samples for chemical analysis and thermal stability assessment. (Protocols were established jointly with the company and this work continued for several weeks leading to detailed investigation of over 30 samples. Analytical work was done at HSE's Occupational Medicine and Hygiene Laboratory); and
 - (d) interview witnesses and examine documentation relevant to the plant, operational procedures etc.

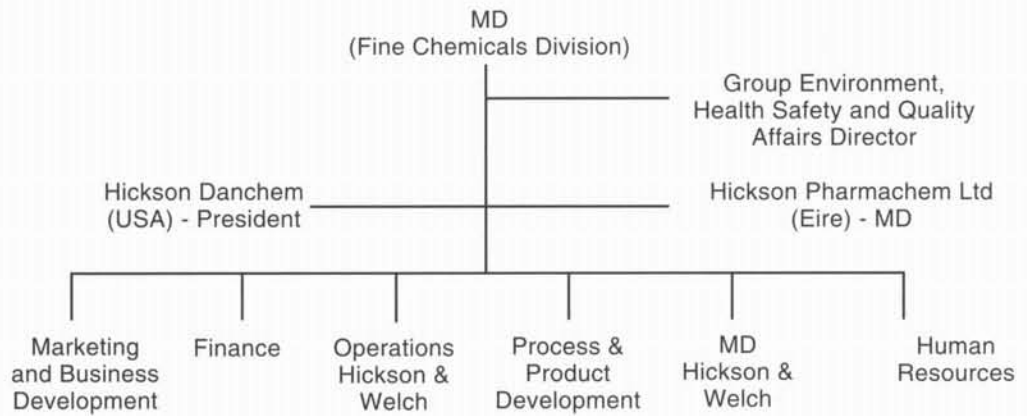

Figure 6(a) Hickson & Welch Ltd - Senior management

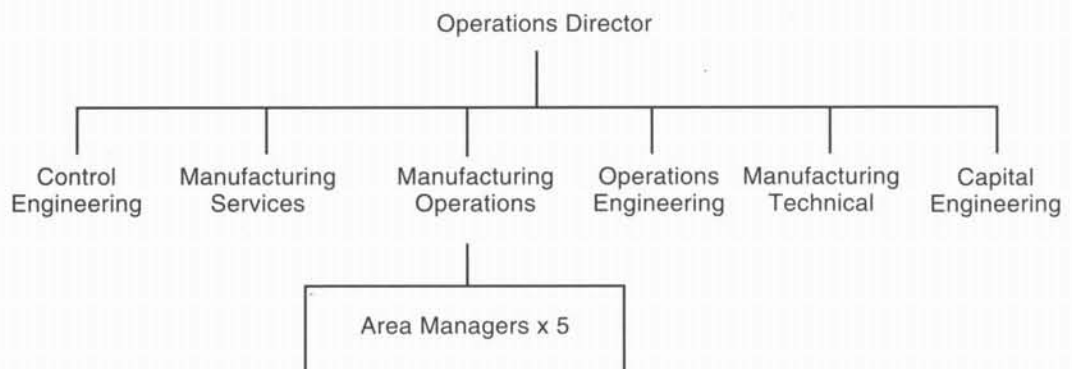

Figure 6(b) Hickson & Welch Ltd - Operational management

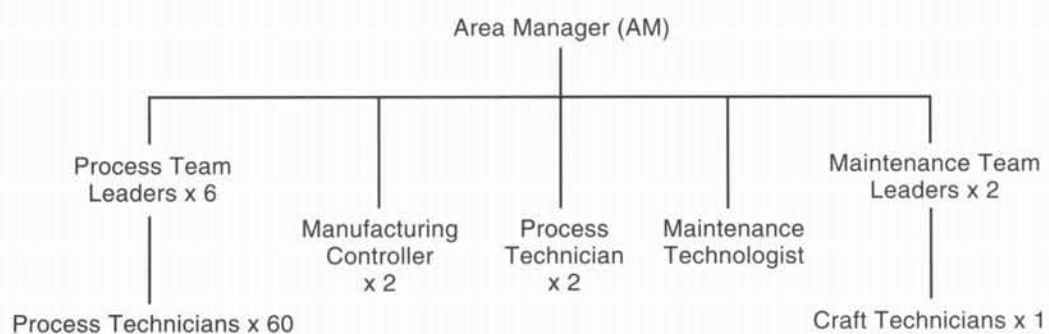

Figure 6(c) Hickson & Welch Ltd - Nitrotoluenes area management

Figure 7 Photograph of the still base

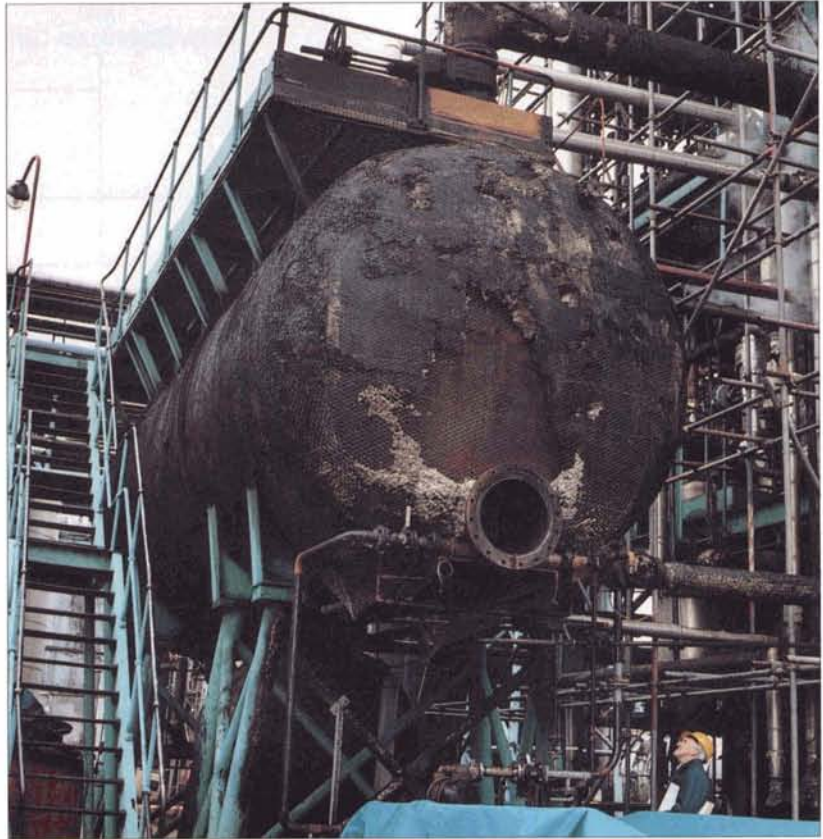

Figure 8 Photograph of the still base, associated plant and panel room

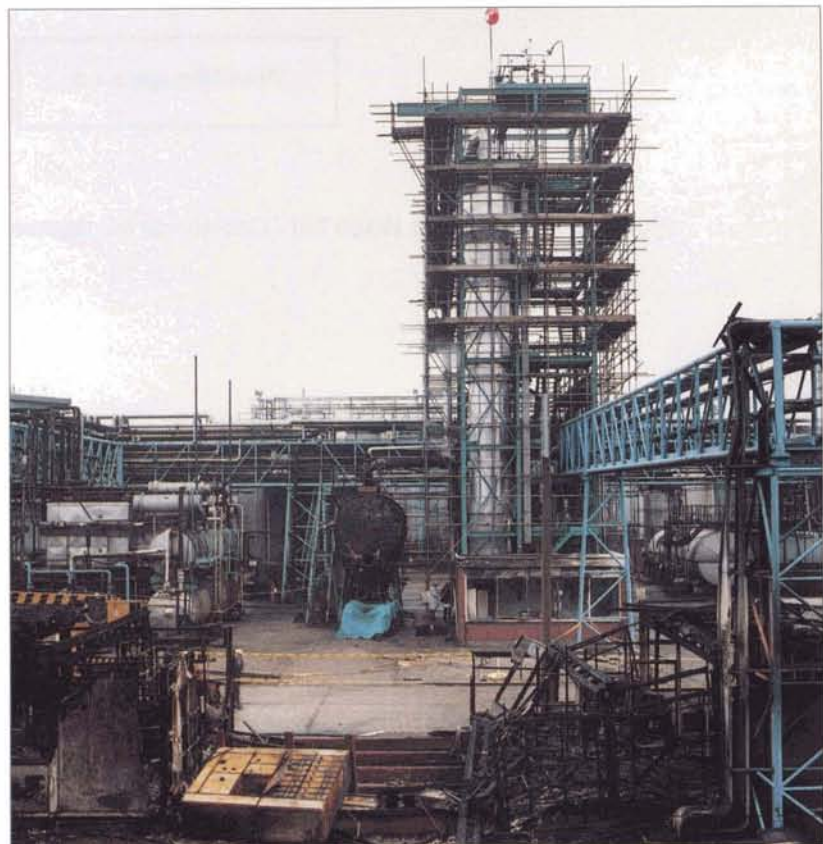

Figure 9 Photograph of roadway and buildings showing direction of the flame and scorch marks on roadway and main office block



Figure 10 Photograph of the north wing of the main office building and adjoining car park



Figure 11 Photograph of smoke damage in the second floor women's toilets



Figure 12 Photograph showing breaches in the fire-resisting enclosure around pipework and cables



As the investigation proceeded additional specialist help was provided by the Control Systems and Process Hazards Groups in HSE's Technology and Health Sciences Division.

- 59 Various articles, including the rake and a large number of documents, were taken into possession. It was found that all of the permits issued for work on 60 still base on 21 September 1992 had been destroyed in the fire.
- 60 Throughout the inquiry, the company, its employees and their trade union representatives provided full co-operation. Statements were taken from 55 witnesses and these and other information were provided for the Coroner, the police and the Crown Prosecution Service before the inquest. There was very close liaison between HSE and these authorities. Liaison meetings were held at relevant stages during the inquiry to discuss progress, the evidence, and action proposed. The police also attended feedback meetings with the company which were organised by HSE.
- 61 It is estimated that the investigation phase took 270 staff days at a cost of £55 000 in staff time alone.

Findings

- 62 The scientific work undertaken by RLSD examined the thermal stability of substances processed in 60 still base and looked at the most likely sequence of events leading to ignition and the jet of flame. In addition, work was also undertaken to assess the duration and radiant output of the flame. The laboratory work was based on chemical samples taken from pipework and storage tanks up and downstream of the still base, although samples were also taken from the still and the skip. Flame duration work was based on fire damaged scaffold boards and painted barge boards from below the roof of the still control panel room (Figure 8).
- 63 Five possible causes of ignition leading to the blue light in the vessel were examined. These were:
 - (a) auto-ignition of flammable vapours in contact with the hot steam battery inside the still base;
 - (b) ignition of flammable vapours resulting from impact or friction between the metal rake and another metallic object;
 - (c) ignition of sensitive solids in the vessel resulting from impact or friction with the metal rake;
 - (d) ignition of flammable vapours by discharge of static electricity; and
 - (e) self-heating and thermal runaway of unstable residues, brought about by contact with the heated steam pipes.

- 64 A variety of test methods were used including differential scanning calorimetry, accelerating rate calorimetry, hot stage microscopy, impact and friction sensitivity tests, and flashpoint, auto-ignition and deflagration* tests (see footnote). In addition ad hoc tests in which samples were heated on a hot block were carried out to observe decomposition and a simulated still base test was also carried out.
- 65 The results of this work suggested that auto-ignition of flammable vapour by contact with the steam pipes and ignition of vapour and sensitive solids by impact and friction could be discounted. Also eliminated was ignition of flammable vapour by electrostatic discharge. The calorimetry and hot block tests however supported the self-heating and thermal runaway hypothesis. Although samples taken from the still base and skip after the incident were thermally inactive, nearly all the samples taken from associated stock tanks and pipework gave involatile residues which underwent exothermic decomposition and self-heating. This suggested that these residues in contact with the steam heated battery would self-heat; this was confirmed by the hot block tests in which slow decomposition of residues from samples developed into rapid reactions, producing temperatures exceeding 500°C. Such temperatures are in excess of the auto-ignition temperature of MNT isomers or the products of decomposition.
- 66 The experimental evidence suggested the following chain of events: thermally unstable residues in contact with the steam heated battery underwent exothermic decomposition which produced sufficient energy to auto-ignite a flammable mixture of MNT vapours or decomposition products. This starting sequence and subsequent ignition is consistent with the fuel rich flame in the still base which may have drawn air through the manway, further heating the bed of residue inside the vessel to the point of deflagration which resulted in the horizontal jet flame.
- 67 Analysis of the scaffold and painted barge board suggested that the jet had a diameter of 4.7 m at 13.4 m from the source, ie at the Meissner control building. The jet lasted for 25 seconds and had a surface emissive power of the order of 1000 kW per square metre and the corresponding flame temperature 6 m from the manway would have been about 2300°C.
- 68 Immediately after the incident the company set up its own internal investigation and later they produced a press release of their findings. They conducted tests similar to those undertaken by HSE and their conclusions about the energetic properties of the materials involved in the incident and the ignition sequence broadly agreed with those of HSE.

Coroner's inquest

- 69 The inquest into the deaths of the five employees who died as a result of the accident was held at Wakefield Coroner's Court from 8-10 March 1993. The jury recorded

* Deflagration is the sub-sonic propagation of a reaction front through a material without the necessary presence of ambient oxygen. The oxygen may come from the material itself.

verdicts of accidental death and they produced a list of contributory factors including:

- (a) the decision to clean out the still base for the first time in 30 years;
- (b) the absence of prior testing of the residue and the atmosphere inside the vessel;
- (c) the application of heat to the still base;
- (d) the accuracy of dipping procedures and temperature measurements;
- (e) the inadequacy of the temperature recording system;
- (f) the absence of policies and procedures relating to the cleaning of vessels at the site;
- (g) the failure to blank off the still base inlet before the work was started;
- (h) the use of a metal rake;
- (i) raking out which took place while heat was being applied;
- (j) the lack of communication between operatives and management;
- (k) the presence of building materials in the Meissner control room;
- (l) the presence of an inward opening door in the Meissner control room which impeded the escape of three employees; and
- (m) the presence of holes in brickwork above the false ceiling of the protected route C in the main office block which allowed smoke ingress into the women's toilet where the fifth casualty was found.

LEGAL PROCEEDINGS

- 70 The inquest confirmed HSE's findings. HSE was aware that the police had prepared a file for the Crown Prosecution Service. After due consideration of all of the evidence and statements the Crown Prosecution Service decided that no criminal charges for manslaughter would be brought.
- 71 A range of charges both in respect of the company and individual managers were considered by HSE. Breaches of duties imposed by the Health and Safety at Work etc Act 1974 and the Fire Certificates (Special Premises) Regulations 1976 were reviewed and the prosecution options, including charges against individuals under this legislation, were discussed with Leading Counsel. It was concluded that the consequences of the accident were primarily due to cumulative management failures and omissions which represented corporate failure. The company was therefore charged, on indictment, with a breach of

duty under Section 2(1) of the Health and Safety at Work etc Act 1974 and the evidence to support this charge covered all aspects and ramifications of this incident.

- 72 The charge against Hickson & Welch Ltd alleged that the company failed to ensure the safety of its employees who were working in the vicinity of 60 still base and were thereby exposed to risks of fire and explosion. The case was heard at Leeds Crown Court on 30 July 1993 before the Honourable Mr Justice Holland. Hickson & Welch Ltd pleaded guilty to the charge and were fined £250 000. Costs of £150 000 were awarded to HSE. Mr Justice Holland concluded that 'there was no safe system of work, none such was maintained, notwithstanding the hazards that were to be perceived, the hazards that were there as a potential. This was not a casual breach of an employer's duty ... but a plain gap in the employer's management which should never have occurred ...'.

MANAGEMENT AND SAFETY SYSTEMS

Management structure

- 73 The management structure of the Fine Chemicals Division of Hickson International plc was re-organised in August 1991. The Fine Chemicals Managing Director led a team of seven directors, one of whom was responsible for the operational activities of Hickson & Welch Ltd. Another director had divisional responsibility for Environmental, Safety and Quality affairs (Figure 6a).
- 74 The Operations Director was responsible for production, engineering and site services. These activities were co-ordinated through six senior managers one of whom was the Manufacturing Operations Manager. Below him there were five middle managers who were responsible for production in five discrete areas (see Figure 6b). The area managers were provided with technical, planning and maintenance support for their respective areas by graduate level manufacturing controllers and process and maintenance technologists. This matrix management system replaced the previous hierarchical structure in which plant managers responsible for small production teams led by supervisors reported directly to an area manager who in turn reported to one of three factory production managers. The new area management system eliminated the role of plant manager, producing a system in which production was co-ordinated through senior operatives who were appointed to act as team leaders. They led small groups of process and engineering technicians in a structure which is illustrated in Figure 6c.

Management of the Meissner plant

- 75 The area manager (AM) who had overall responsibility for the nitrotoluenes area had worked at the factory for over 30 years. Under the previous management system he had worked as plant manager on the Meissner plant.
- 76 In the nitrotoluenes area the AM was responsible for over 70 people, including nine team leaders, 16 leading hands and 45 process technicians. The manufacturing technologists

who assisted the AM reported directly to their respective managers at a level above area manager. The new system was not without its critics. Area managers were generally acknowledged to have significant workloads. They were responsible not only for production activities within their areas but also for maintenance which had previously been the responsibility of the Works Engineering Department. A number of the area managers had approached senior management about their problems and in specific areas this was under review. The team leader system only became operational in the nitrotoluenes area on 7 September 1992.

- 77 The factory operated a four-shift system. Twenty process technicians worked on the Meissner plant with five on duty per shift. The system also ensured that a minimum of two team leaders were on site each shift. Their work covered all activities in all sections of the nitrotoluenes area. At the time of the accident on 21 September 1992 employees on shifts 1 and 4 were overlapping. There were five team leaders on site and they were all working in the vicinity of 60 still base.

Health and safety management

- 78 The Safety Department at Hickson & Welch Ltd is lead by a safety manager who is assisted by a fire officer and a safety officer. At the time of the incident they reported to the environmental, safety and quality affairs director but they also liaised with loss control superintendents and shift site managers who provided 24 hour cover. The superintendents and shift managers were nominated to act as incident controllers if emergencies arose. The Safety Department's function is to advise, promote and co-ordinate activities in health, safety and emergency procedures. Responsibility for ensuring health and safety rests with the line management and this is made clear in the company health and safety policy.
- 79 In 1988 Hickson & Welch sought advice from HSE about health and safety management (see paragraph 100) and after this initiative they commissioned a health and safety audit from an international firm of loss control consultants. Following the audit Hickson & Welch Ltd revised their health and safety policy statement and embarked on a programme recommended by their consultants to improve health and safety management. It was realised that training was required at managerial and supervisory levels within the company before the programme could commence.
- 80 The revised company health and safety policy statement referred specifically to programmes to control foreseeable hazards and in 1990 the company set about training management and setting performance standards for management training, leadership and administration, planned inspections and accident/incident investigation.
- 81 The company also introduced annual safety programmes and in May 1991 they published an internal document which set standards to improve the company's lost time accident record, accident/incident investigation and task analysis. Restructuring within the company, which was taking place at the same time (paragraph 73), interrupted progress towards these objectives, which were revised for the following year.

- 82 At the time of the accident the company was formulating other performance standards dealing with emergency preparedness, organisational rules, employee training etc and work was in progress to prepare a safety booklet for all employees. With regard to planned inspections however records revealed that area managers were not achieving targets and this was said to be due to lack of time.

Permit to work procedures

- 83 The current permit system was introduced in March 1989 and relevant employees were trained in its use. The procedure was formalised, computer-based and generally triggered by a written Work Request. This led to a written Job Card which incorporated a Safety Planning Certificate. Completion of the Certificate was generally a team leader's responsibility and this identified whether supplementary permits were required. These were available for electrical isolation, burning, vessel entry, excavations and hazardous work.
- 84 Team leaders were also authorised to issue Hazardous Work Permits, however permits for burning and vessel entry required authorisation by a manager. When team leaders completed Job Cards and Hazardous Work Permits they were expected to read through the safety planning sections with recipients to ensure that they understood the scope of the work, the hazards involved and precautions required. Copies of Job Cards and Permits were accepted in writing and taken to the job; duplicates were retained by management.
- 85 Three Hazardous Work Permits were issued for two jobs on 60 still base on 21 September 1992 (paragraphs 31 to 33). These permits were issued by a team leader who had not worked on the Meissner plant for 10 years, preceding his appointment on 7 September 1992. This team leader attended refresher training on the permit system on 25 August 1992 but had not received any refresher training for his work on the Meissner plant.
- 86 Two Hazardous Work Permits were issued for the removal of the manlid (paragraph 31). The third Hazardous Work Permit was issued after the manlid had been removed, when it was realised that the inlet to 60 still base had not been blanked off. None of the permits issued on the day of the accident referred specifically to the task which was to be undertaken, ie raking out the sludge.

HEALTH AND SAFETY LEGISLATION

- 87 The factory occupied by Hickson & Welch Ltd was subject to the Health and Safety at Work etc Act 1974 (HSW Act), the Factories Act 1961 and subordinate legislation for which HSE is the enforcing authority. The HSW Act imposes general duties on employers towards employees, members of the public and others. Section 2 of the Act requires that employers should ensure, so far as is reasonably practicable, the health, safety and welfare at work of all of their employees. Responsibilities are also given to directors, managers and other individuals who are subject to specific provisions of the Act.

- 88 Since the accident new regulations important to all senior managers, which add to the general requirements of the HSW Act, have come into force in the Management of Health and Safety at Work Regulations 1992. These regulations came into force on 1 January 1993 and their main provisions encourage a more systematic and planned approach to health and safety management which is based on assessment of risks in the workplace.
- 89 The factory was also subject to requirements of the Notification of Installations Handling Hazardous Substances Regulations 1982 (NIHHS) and the Control of Industrial Major Accident Hazards Regulations 1984 (CIMAH). The NIHHS Regulations require notification by companies of quantities of specified hazardous substances above prescribed limits. Hickson & Welch Ltd was subject to NIHHS because of the storage of liquefied petroleum gas, oleum and chlorine. None of these installations, which were outside the nitrotoluenes area, was affected by the incident.
- 90 The CIMAH Regulations are designed to prevent or mitigate the affects of major accidents to people and the environment and they operate at two levels. At sites where the full provisions apply manufacturers are required to produce a written safety report which should contain details of relevant dangerous substances, the installation, management system, potential for major accidents and the conditions or events which could be significant to prevent, control and minimise the effects of major accidents. In addition there are separate requirements for on-site and off-site emergency plans which should be prepared by the manufacturer and local authority respectively. These are intended to mitigate the effects of major accidents and prepare responses to them.
- 91 Manufacturers are also required to ensure that people who might be in the area where they could be affected by a major accident are informed of the nature of the hazards and the action they should take for their own safety in an emergency. For this purpose, HSE designates a public information zone within which the manufacturer is required to circulate this information. The emergency planning and public information requirements of the CIMAH Regulations were fully satisfied by Hickson & Welch Ltd.
- 92 The top tier requirements of the CIMAH Regulations (regulations 7-12) applied from the outset to Hickson & Welch Ltd by virtue of the company's storage and use of chlorine and arsenic acid. These requirements did not apply to the Meissner plant. Further substances came within the scope of regulations 7-12 when the Second Amendment to CIMAH came into force on 31 March 1991. These substances included the isomers of MNT (see paragraph 18) as regards storage only. These and other qualifying substances were notified to HSE on 26 March 1991 and the off-site emergency plan and information to the public were modified accordingly. The Safety Report for these substances does not have to be submitted to HSE until 1 June 1994. The Meissner plant is not subject to CIMAH but associated storage for MNT is.
- 93 HSE considered that the incident was a major accident as defined by CIMAH Regulations and a report of the occurrence detailing the circumstances, the substances involved, the preventative measures and other information specified in Schedule Five of

the regulations has therefore been sent to the Commission of the European Communities.

- 94 Certification as to means of escape and other general fire precautions is usually the responsibility of the fire authority; however the Fire Certificates (Special Premises) Regulations 1976 make HSE the body responsible at premises where among other things substantial quantities of specified hazardous materials are handled. Activities undertaken by Hickson & Welch Ltd at the factory brought the company within the scope of these regulations which set performance standards with regard to means of escape, means of fighting fire, means of giving warning in case of fire and other general fire precautions including provision of notices, fire safety training etc. The general fire precautions required under these regulations are principally concerned with enabling people to escape to safety from a building or area which is on fire. These precautions however cannot and were not intended to deal with extreme situations such as the rapid spread of fire from one part of a site to another or the intense blast of a jet flame.
- 95 The section of the fire certificate for the main office block was originally issued by HSE on 11 September 1980 (see also paragraphs 48 and 105). The section of the fire certificate which covered the Meissner control building was issued on 30 April 1985.

HSE AND HICKSON & WELCH LIMITED

- 96 In October 1986 HSE prosecuted Hickson & Welch Ltd following a chemical incident which had off-site consequences. Two charges were brought against the company under the HSW Act. The charges were heard at Castleford Magistrates' Court where the company pleaded guilty and was fined £2000.
- 97 In the period following these proceedings the main aims of HSE's inspection regime at the factory were:
- (a) to conduct a planned preventative inspection with particular emphasis on those parts of the site defined as 'major hazard installations' (paragraphs 89 to 92);
 - (b) to investigate significant accidents, incidents and dangerous occurrences in order to discover the underlying causes, particularly in respect of management systems failures which contributed to these events; and
 - (c) to collate information on the company's performance from the above activities and to present this as evidence to senior management, periodically, to justify improvements in the management of health and safety.
- 98 Inspections carried out at the factory by HSE between October 1986 and September 1992 have concentrated on issues associated with the major hazard installations subject to the first application of CIMAH (see paragraph 92). The frequency of inspection was commensurate with the risks at these plants, but visits were also made to investigate

accidents, incidents and dangerous occurrences etc. Many of these inspections and investigations resulted in formal advice requiring specified improvements to plant and systems of work which were implemented by the company. The section of the nitrotoluenes area which includes the Meissner plant last received a preventative inspection in February 1990.

- 99 Since 1987 two enforcement notices have been served on Hickson & Welch Ltd, both arising from conditions on and improvements required at a major hazard installation which was remote from the nitrotoluenes area. Both of these notices were complied with.
- 100 With regard to health and safety management, the company requested advice from HSE's Accident Prevention Advisory Unit (APAU) (see paragraph 79). In April 1988 APAU held a one-day seminar for the management of Hickson & Welch Ltd and employee trade union representatives. This seminar introduced management at all levels to the idea of auditing the company's health and safety policy statement and the organisation and arrangements for its implementation. Following the seminar, proprietary auditing systems were reviewed by the company and in 1989 they appointed an independent firm of loss control consultants to carry out a site audit. The results of this audit were disclosed to HSE by the Hickson Group Environmental, Safety and Quality Affairs Director who had been given responsibility for implementing the audit recommendations (see paragraphs 78 to 82).

CONCLUSIONS AND LESSONS TO BE LEARNED

Conclusions about prevention arrangements

- 101 The technical, research and production departments at Hickson & Welch Ltd employed highly qualified staff with a considerable amount of expertise in the manufacture of organic nitro compounds. Before the change in the Meissner area in 1988 the company carried out several studies to review a number of options for removal of nitrocresols from MNT. The development department conducted a predictive assessment of thermal stability hazards associated with allowing nitrocresols to pass through the process stream. In a report produced by the then AM in February 1988 he concluded that "the practice of distilling large inventories in 60 still base of 'potentially' unstable materials is not wise". The predictive assessments however contradicted this view and when plant trials were carried out in the spring of 1988 it was found that the thermal stability of the substances involved was much greater than had been forecast by earlier simulations. The process change to remove DNT and nitrocresols in 60 still base was therefore introduced in October 1988. Operating procedures based on batch sampling and thermal stability testing were introduced to maintain what was considered to be an adequate margin of safety (see paragraphs 24 and 25). The process change, however, was later found to have disadvantages which principally concerned quality and increased down time of the continuous stills due to accumulation of solid by-products. These were thought to be associated with the degradation of DNT and nitrocresols.

- 102 At the time of the accident senior technologists in the company were investigating this problem but the work was proceeding slowly and causing a certain amount of frustration. On 15 June 1992 a senior process technologist wrote to senior management expressing his frustration in a memo which stated that "it is my view that we are within five years of a major accident on the MNT distillation system". This concern related specifically to the risk of a major accident involving fire and explosion in one of the continuous stills due to impaired operating conditions but it reflected the knowledge and experience within the company about the hazards associated with residues in the MNT system as a whole.
- 103 Regrettably this level of understanding was not reflected in the decision which was made on 21 September 1992 when it was decided that 60 still base would be raked out. This omission was compounded by other errors identified by the jury at the Coroner's inquest (paragraph 69). The fire itself was triggered by the fatal decision to apply heat through the bottom steam battery. Although this instruction was qualified with the advice that the temperature should not exceed 90°C it did not take account of the limitations of the temperature monitoring system provided for the vessel which was not capable of monitoring the temperature distribution of the sludge. The instruction was based solely on the fact that 90°C is below the flashpoint of MNT isomers.
- 104 The accident could have been prevented if the clean out operation, which had never been done in the previous 30 years, had been subjected to a thorough hazard assessment to devise a safe system of work. The task however was dealt with locally without referral to senior management or reference to formal procedures which existed for cleaning out other still bases at the factory. Some of these involved high pressure water jetting by specialist contractors whose involvement required scheduled planning.
- 105 The Meissner control building was covered by the section of the fire certificate issued by HSE in 1985. The building had two outward opening doors (see Appendix 2) but the west end door opened inwards. Ordinarily it was used by fewer than ten people, but the inward opening west end door delayed the escape of the three employees who survived the initial blast. Part 1 of the fire certificate stated that all doors forming part of a means of escape should open in the proper direction, ie outwards. This was qualified in Part 10 of the certificate which stated that if fewer than ten people were required to use a door, the direction of opening was not controlled except from high fire risk sections of the premises. In accordance with current standards, because fewer than ten people were ordinarily employed and because the building did not house high fire risk plant, outward opening doors were not specified.
- 106 With regard to the main office building reference has previously been made to breaches in the fire-resisting enclosure defined in the relevant section of the fire certificate as protected route C (paragraph 48). Investigation failed to reveal when these holes, which are illustrated in Appendix 4 and Figures 11 and 12, were made. They may have resulted from internal alterations and could have been left following installation of a new fire alarm system in 1990. It was concluded that if the required level of integrity of the protected route had been maintained rapid ingress of smoke into this and particularly the toilet accommodation might not have occurred.

Action by the company

- 107 Immediately following the accident the company suspended manufacturing operations on the MNT plant and a technical committee was set up to look at alternative methods to remove DNT and nitroresols from the manufacturing system. A range of options was evaluated with the aid of independent consultants and the firm's conclusions were discussed with HSE. The company concluded that the system (briefly described in paragraphs 15 to 17) should be modified to eliminate batch distillation of whizzer oil in 60 still base. A system involving distillation followed by fractional crystallisation was devised and assessed before MNT production re-commenced.
- 108 After the examinations of 60 still base were concluded the vessel was decontaminated and removed from the nitrotoluenes area. The new DNT/nitroresols separation system has increased the amount of waste generated on the MNT plant and this is now removed from site for incineration as 'Flammable Toxic Waste'.

LESSONS

- 109 This tragic accident highlighted a number of lessons which are considered relevant for the chemical industry and emergency services. Most of these lessons are familiar and may already have been addressed at other sites. However, all chemical manufacturing companies should review their safety management systems to ensure that they have adequately addressed the lessons which are set out below.
- 110 The accident arose following an attempt to remove sludge which had accumulated in a still base (see paragraph 28). This material, which was heated to make it soft, was thought to be affecting the efficiency of the plant. Materials processed in the vessel were known to be highly energetic but no attempt was made to monitor residue accumulation even after a significant process change was introduced in October 1988. The view of the Hickson & Welch management was that the level of residue in the still base ebbed and flowed with successive distillations. On 21 September 1992 however the AM authorised removal of sludge from 60 still base without any attempt to identify this material, the hazards and the risks involved. The residue contained organic nitro compounds and it is well known^{1,2} that these substances can be induced to undergo exothermic decomposition at elevated temperatures, leading to thermal runaway.

Lesson 1

Where the batch distillation of highly energetic materials (such as mononitrotoluenes or other organic nitro compounds) is carried out still residues should be analysed, monitored and removed at regular intervals to prevent possible build up of unstable impurities.

- 111 Several days before the accident 60 still base was used to vacuum out a thick residue from two whizzer oil storages. This operation was not authorised at an appropriate level by management. Transfer of material from the still base into waste tank 193 proved

difficult after the vacuuming operation which was then followed by two batch distillations that were completed by 20 September 1992.

Lesson 2

The use of chemical plant for a different process or purpose should be treated as a plant change procedure requiring rigorous assessment. Consequently, before plant is used to carry out non-routine operations authorisation should be obtained from an appropriate level of management who should ensure that plant hazards have been identified, risks assessed and the precautions determined.

- 112 60 still base had not been opened for cleaning in the previous 30 years and operating procedures for the plant were old. They had not been revised following the process change in October 1988 and they made no reference to maintenance and clean out . Formal cleaning procedures requiring water jetting were available for other still bases used at the factory.

Lesson 3

Safe systems of work covering all aspects of operation and maintenance of all process plant should be established and defined in comprehensive instructions including those operations undertaken at infrequent intervals. These systems should be monitored by management and reviewed at appropriate intervals.

- 113 Preparatory work for removal of residue from 60 still base was authorised by newly designated team leaders (previously supervisors) following brief discussion with their AM. He authorised application of heat through the bottom steam battery without previously checking that the temperature of this residue could be monitored. He assumed that the still base thermometer probe would record its temperature but was not aware of the limitations of this system for that purpose. The issue of permits for the activities that followed involved a team leader who had recently been relocated back to the Meissner plant. He had not received refresher training but was allowed to authorise removal of the still base manlid and the fitting of a blanking plate using the company's permit to work procedure. The permits issued were not checked by the AM and a permit was not issued to cover the use of a metal tool for the raking out operation. Other elementary mistakes were made. The atmosphere inside the still base was not tested for flammable vapour and the sludge was not sampled and analysed. The fatal mistake however was the application of heat through the bottom steam battery. The hazards and risks were not assessed and the job was not planned. The AM was dealing with several other problems which required his attention and one of his manufacturing controllers was on holiday. The newly appointed team leaders therefore assumed most of the responsibility for the task.

Lesson 4

The nature, operation and limitations of control systems on process plant should be determined, and their implications for health and safety taken into account, before non-routine operations requiring their use are authorised.

Lesson 5

Companies should assess and monitor the workload and other implications of restructuring levels of management and supervision to ensure that key personnel have adequate resources, including time and cover, to discharge their responsibilities.

Lesson 6

Persons authorised to issue permits to work should be sufficiently knowledgeable about the hazards associated with relevant plant. If 'authorised' personnel are relocated to former workstations refresher training should be given and recorded before re-authorisation.

- 114 The Meissner control building, which was first installed in 1979, had a number of functions. It housed lockers, showers, offices and some control equipment. Its lightweight structure offered no protection from the heat and blast of the fire. Formal assessment of the risks to the building and those who used it from surrounding plant had never been carried out and the possibility of exposure to a jet fire had not been foreseen. A limited amount of technical guidance is currently available to industry on this subject^{4,5} and this information can be used to form the basis for assessment of control building design and location.

Lesson 7

The design and location of control and other buildings near chemical plant which processes significant quantities of flammable and/or toxic substances should be based on the assessment of the potential for fire, explosion and/or toxic releases at these plants. Companies should assess the suitability of existing control buildings and if they are found to be vulnerable reasonably practicable mitigating action should be taken.

- 115 Examination of the means of escape from the main office building revealed breaches in the fire-resisting structure on the second floor of protected route C. These breaches above a false ceiling led to smoke logging of the means of escape and also probably caused smoke logging in an adjacent toilet. Inspection and examination following alterations (see paragraph 106) and regular monitoring of performance standards prescribed in the firm's fire certificate should have been carried out by the company to ensure that the integrity of escape routes was maintained. Furthermore, although the company had formal procedures to provide and record 'fire training' (required by their fire certificate) there was no written confirmation that the fifth fatality, a temporary office worker, had been so trained.

Lesson 8

Companies should regularly monitor and audit their own compliance with performance standards defined in their fire certificates. Particular attention should be paid to the effects of material alterations, eg installation of pipework and cable ducts and other work in areas concealed by false ceilings, to ensure that the fire-resisting integrity of protected routes is maintained and fire training records should be regularly updated.

116 In the confusion which followed the incident, and due to absence from site over the lunch period of a large number of staff, problems were experienced by those carrying out roll calls at designated locations. Information was fragmented but within 10 minutes of leaving the building it was established that a person was missing in the main office block. This information was communicated to the fire brigade but the officers who eventually recovered the casualty (at 2.03 pm) entered the building without any prior knowledge of the casualty's suspected location.

Lesson 9

When exercising their on-site emergency plans companies should ensure that roll call information on missing persons is passed immediately, accurately and directly to the senior fire officer in charge. Roll call procedures should be practised routinely to ensure that they are effective when carried out at all periods of the working day.

REFERENCES

- 1 Lewis R J Snr *Sax's Dangerous Properties of Industrial Materials* Van Nostrand Reinhold 1992
- 2 Bretherick L *Handbook of Reactive Chemical Hazards* Butterworths
- 3 Harris G F P, Harrison N and McDermott P E *Hazards of the Distillation of Mono-nitrotoluenes* I Chem E Symposium Series No 68 p4/W:1 March 1976
- 4 Marshall V C *The Siting and Construction of Control Buildings - A Strategic Approach* I Chem E Symposium Series No 47 p187 September 1981
- 5 Chemical Industries Association Ltd *An Approach to the Construction of Process Plant Hazard and Control Building Design* 1979 (Out of Print - currently under revision)

APPENDICES

Appendix 1 Plan of the factory and immediate surroundings

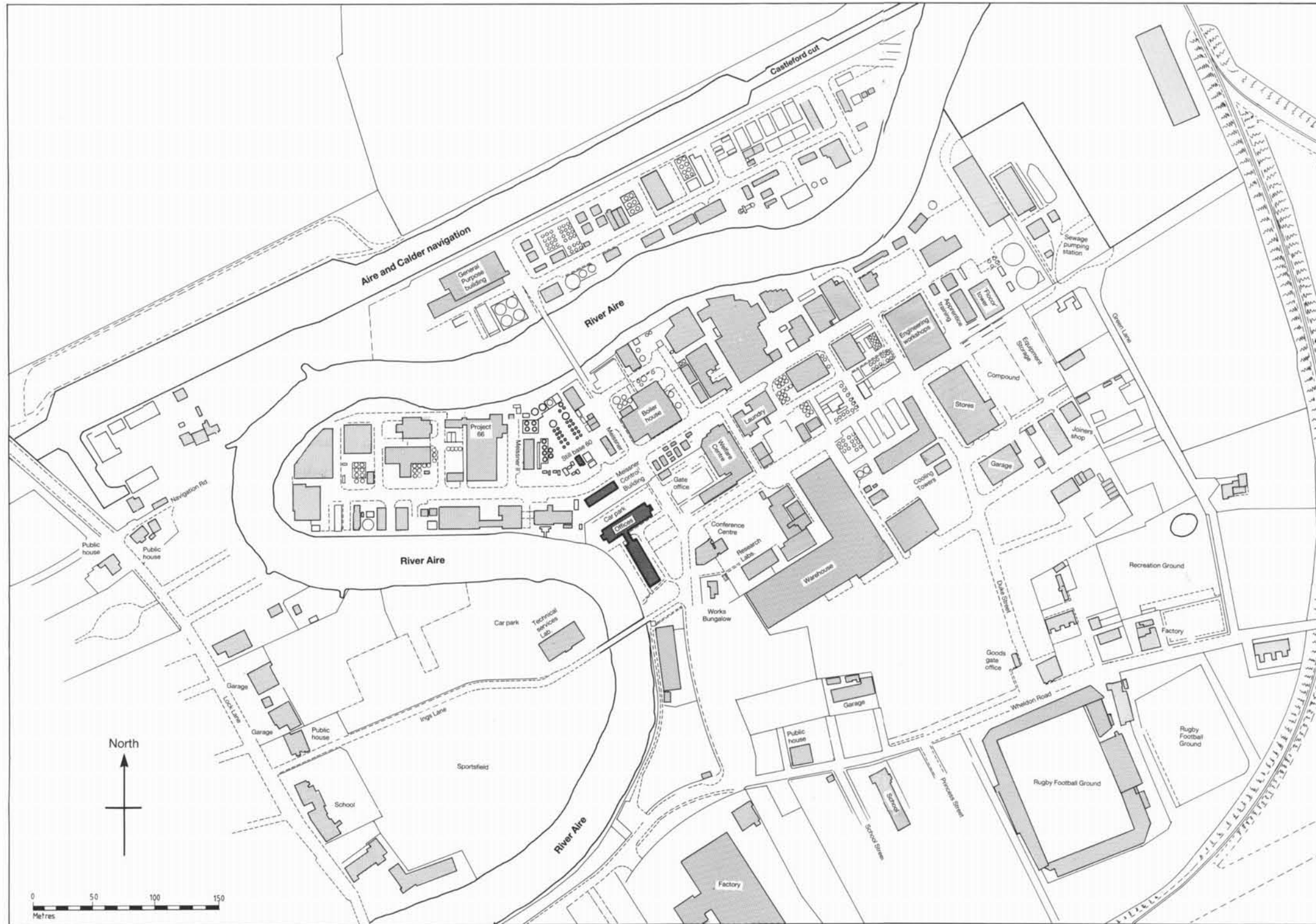

Appendix 2 Plan of Meissner control building showing extent of fire damage

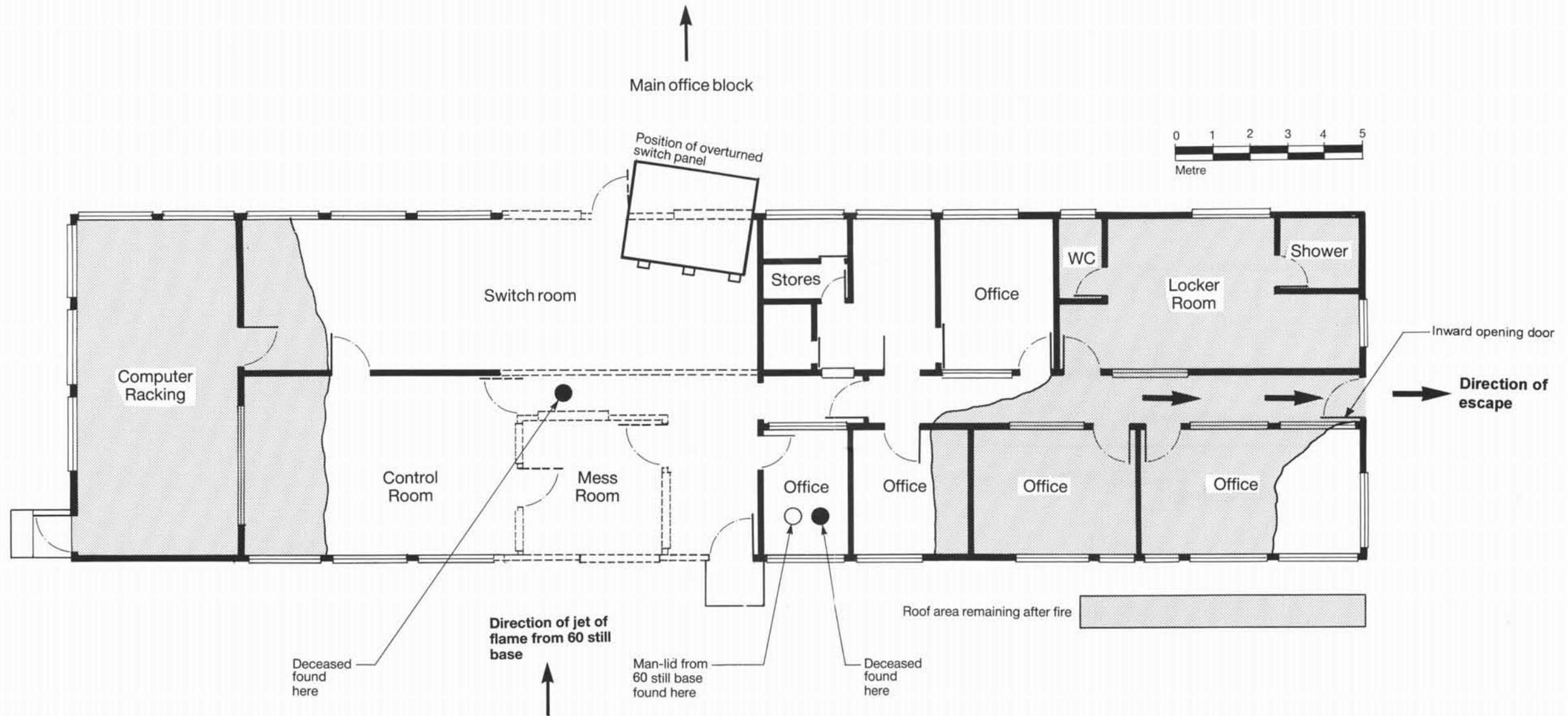

Appendix 3 Plan of the second floor of the main office block

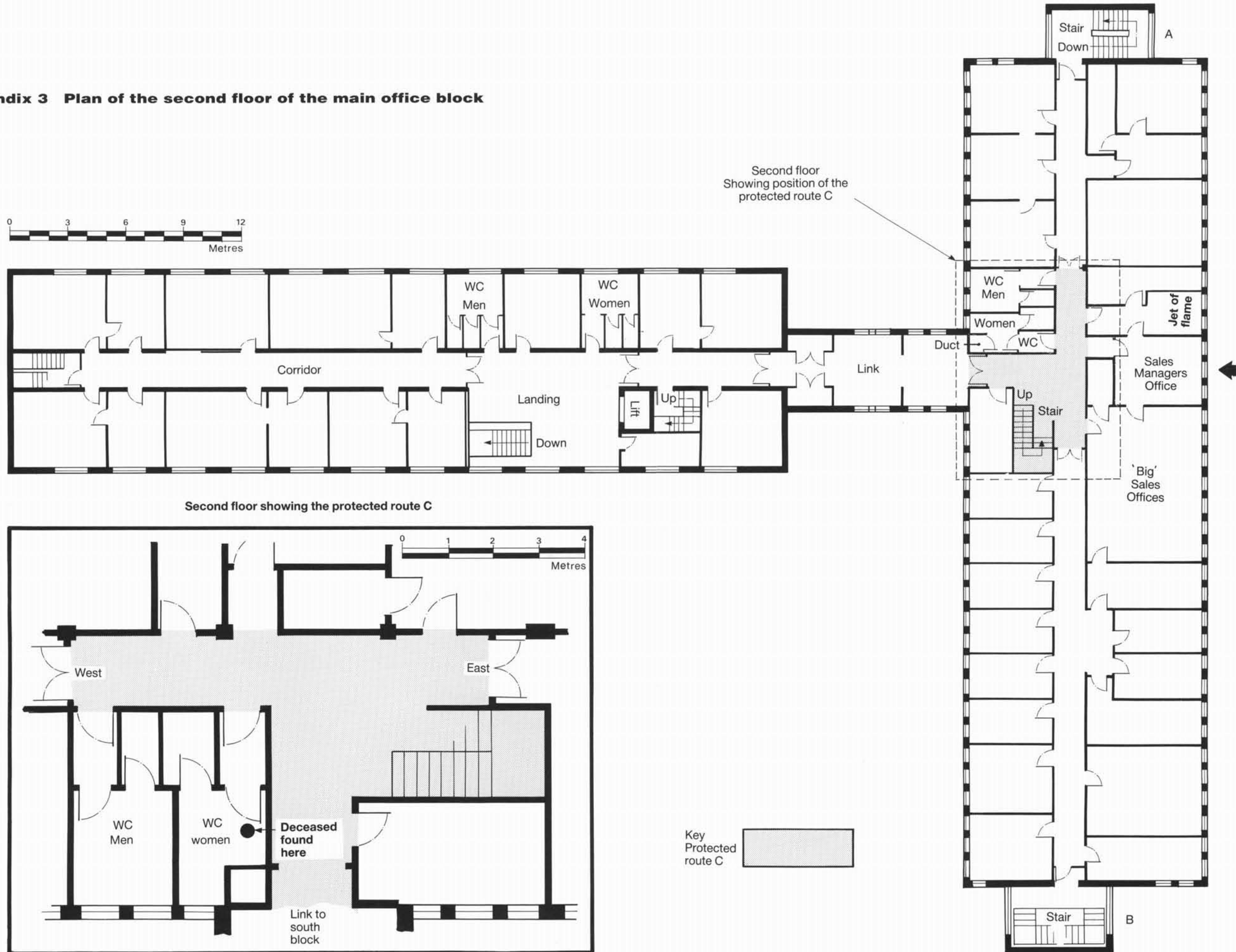

Appendix 4 Three-dimensional drawing of the smoke route through protected route C

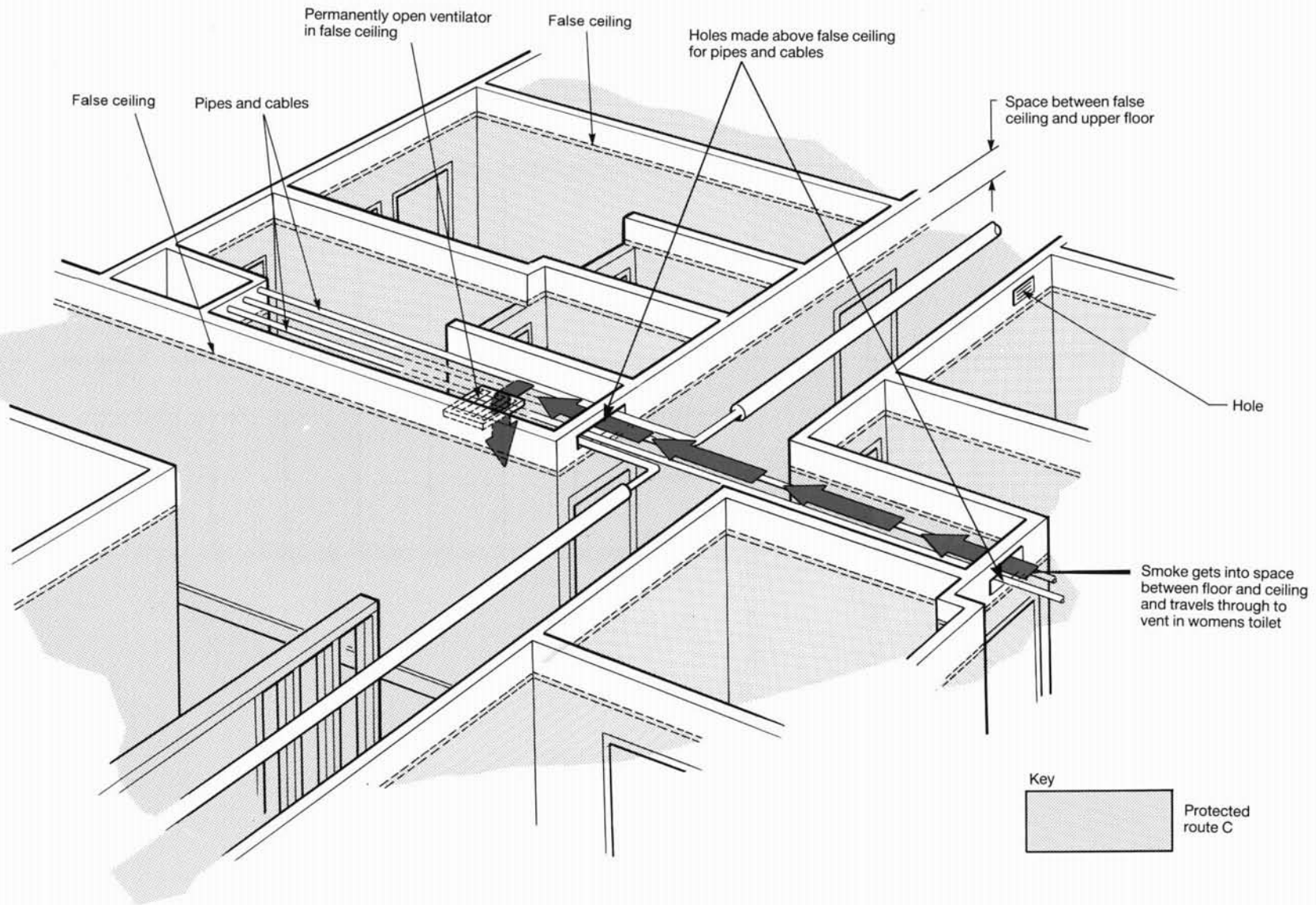



MAIL ORDER

HSE priced and free
publications are
available from:

HSE Books
PO Box 1999
Sudbury
Suffolk CO10 6FS
Tel: 0787 881165
Fax: 0787 313995

RETAIL

HSE priced publications
are available from Dillons
Bookstores nationwide and
can also be ordered at any
branch of Ryman the Stationer
(see *Yellow Pages* or *telephone*
071 434 3000 for local details)

PUBLIC ENQUIRY POINT

Health and safety enquiries:
HSE Information Centre
Broad Lane
Sheffield S3 7HQ
Tel: 0742 892345
Fax: 0742 892333

£ 11.00 net

ISBN 0-7176-0702-X



9 780717 607020