

## ROUND ROBIN VENT SIZING EXERCISE ON A GASSY SYSTEM: 40% DICUMYL PEROXIDE IN BUTYRATE SOLVENT<sup>†</sup>

L. Véchet<sup>1,4</sup>, Jake Kay<sup>1</sup>, Jill Wilday<sup>1</sup>, Douglas Carson<sup>2</sup> and Jean Pierre Bigot<sup>3</sup>

<sup>1</sup>Health and Safety Laboratory, Buxton, Derbyshire, UK

<sup>2</sup>INERIS, Verneuil en Halatte, France

<sup>3</sup>Ecole nationale supérieure des mines, Saint-Etienne, France

<sup>4</sup>currently Texas A&M University at Qatar, Doha, Qatar

A Round Robin test was set up to obtain a cross comparison of participant's methods regarding a typical pressure relief device (bursting disc) sizing problem. The problem in question was a 'gassy' runaway reaction system: decomposition of 40% w/w dicumyl peroxide in 2,2,4-trimethyl-1,3-pentanediol diisobutyrate. The objective of the Round Robin exercise was to highlight the disparities in the participant's approaches and identify barriers and research needs.

Two broad methods were used: one was the implementation of the DIERS method; the other was to follow a similarity or scale-up approach. The scale-up approach consists experimentally determining a minimum safe vent area and scaling up maintaining the vent area/volume ratio. This approach is similar to the one adopted by the UN committee on the Transport of Dangerous Goods for vent sizing of peroxide tankers using a 10 litre vessel.

Very different results in terms of vent area were obtained from the seven participants.

Analysis of the vent sizing calculations based on calorimetric data showed that the experimental conditions and their interpretation can significantly influence the estimated gas production rate and therefore the final vent area. However, the calculation of the vented mass flux stays largely responsible for the differences in calculated vent area. The critical factor lies in the assumption of single-phase (gas only) venting or two-phase (liquid and gas) venting. The reasons for assuming single-phase venting, which gives a lower vent area, are unclear and may not be justified.

The comparison showed that the calorimetric and the similarity approaches diverged significantly when two-phase only venting was assumed. The Round Robin test highlighted the need for more experimental and modelling work towards predicting the nature of the vented fluid at large scale, and in the use of adiabatic calorimetry to determine the maximum gas production rate. Large-scale tests would allow the comparison, the validation and the improvement of the calorimetric and similarity approaches.

**KEYWORDS:** Runaway reaction, pressure relief systems, adiabatic calorimetry, reaction kinetics, dicumyl peroxide, UN method

### INTRODUCTION

The state of the art in sizing pressure relief systems is based on small-scale measurements in an adiabatic calorimeter and two-phase flow models developed by the DIERS studies [1]. However, these methods can sometimes lead to oversized vent areas, especially for untempered gas generating systems. There has been relatively little experimental validation of DIERS vent sizing methods for such reactions. An alternative method has been adopted by the UN committee on the Transport of Dangerous Goods for vent sizing of peroxide tankers using a 10 litre vessel to experimentally determine the minimal vent size that can prevent the explosion of a portable tank exposed to a fire [2]. The scale-up is carried out by maintaining the vent area to vessel volume ratio. However the validity of the scale-up

rules does not reach a general acceptance [3]. There can be significant differences between different methods (DIERS/UN 10 litres). The UK Health and Safety Laboratory and INERIS (FR) jointly proposed a Round Robin exercise on an untempered system. Seven chemical companies and public laboratories volunteered to participate (École Nationale Supérieure des Mines de Saint Etienne (FR), Health & Safety Laboratory (UK), INERIS (FR), Rhodia Recherches et Technologies (FR), Fauske & Associates (US), Stazione sperimentale per i combustibili (IT), Sanofi-Aventis (FR)). The objective of this Round Robin test was to achieve a cross comparison of different participants' results and methods regarding a typical problem in order to identify the differences, the barriers and the research needs. The idea was to compare the results obtained by the different laboratories on a model chemical system for which

<sup>†</sup>© Crown Copyright 2011. This article is published with the permission of the controller of HMSO and the Queen's Printer for Scotland.

This publication and the work it describes were partly funded by the Health and Safety Executive (HSE). Its contents, including any opinions and/or conclusions expressed, are those of the authors alone and do not necessarily reflect HSE policy.

difficulties linked to the presence of vapour are minimised: a system close to a pure gassy system.

## DESCRIPTION OF THE ROUND ROBIN EXERCISE

The chosen scenario for the Round Robin test was the decomposition of an untempered reactive mixture in a 340 litre vessel under fire loading ( $0.5\text{ }^{\circ}\text{C}/\text{min}$ ) (Table 1, Figure 1). The vessel jacket is assumed to have failed (no possible cooling). The chosen chemical system is a solution of 40% w/w dicumyl peroxide in 2,2,4-trimethyl-1,3-pentandiol diisobutyrate. This system can be considered as an almost pure gassy system, showing low ambiguity with a tempered system [4]. The fire scenario was chosen to allow the possibility of UN 10 litre tests subsequently. Table 2 summarises the data to be used in the calculation.

The main objective of this Round Robin test was to determine a suitable vent area to protect the 340 litre vessel, which has a maximum allowable pressure of 7 bara. The expected calculation was limited to the calculation of the diameter of a bursting disc to be installed on the vessel. To simplify and ease the comparison of the results, the following assumptions were made:

- The vessel is equipped with a very short vent pipe and the disc itself has a low frictional resistance after bursting.
- The pressure change associated with the inlet contraction from the vessel is assumed to dominate the overall dissipation effect on flow capacity. The value of the discharge coefficient is  $C_d = 0.816$ .
- The short vent line is open to the atmosphere.

## RESULTS

Seven companies, with a wide range of experimental facilities, participated in the Round Robin exercise (Table 3).

**Table 1.** General vessel specifications

	Vessel	Jacket
Working Pressure (kPa)	0 to 700	0 to 700
Design Pressure (kPa)	0 to 760	0 to 760
Test Pressure (MPa)	1.24	1.24
Temperature Range (K)	248 to 473	
Capacity ( $\text{m}^3$ )	0.340	0.085
Material	Glass lined mild steel	Mild steel
Outer Diameter (mm)	700	800
Outer Wall Thickness (mm)	10 (side)/ 8 (bottom)	6
Top Shell Height (mm)	220	
Bottom Shell Height (mm)	800	
Agitator Diameter (mm)	420	
Agitator Height (mm)	$95 \pm 5$	

Source: HSL

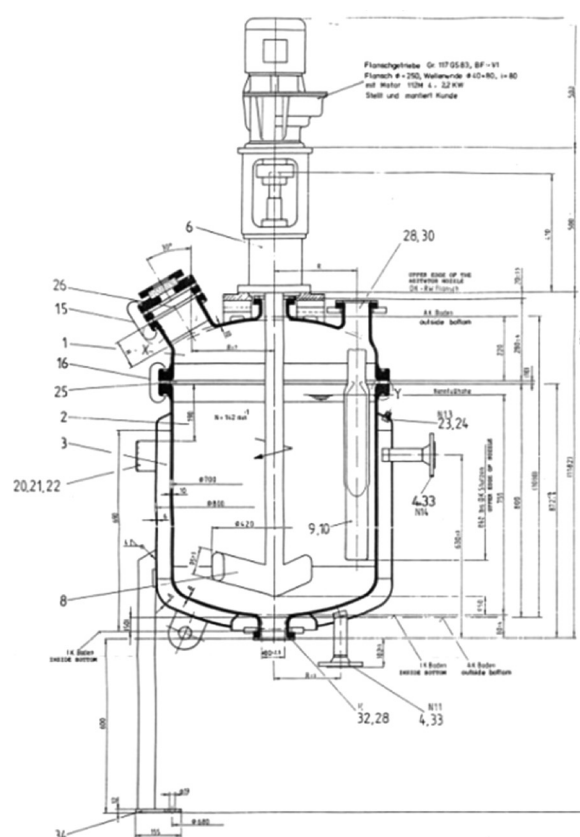

**Figure 1.** 340 litre vessel (HSL)

Those facilities mainly comprise adiabatic calorimeters, but also reactor vessels equipped to carry out venting experiments.

## VENT SIZING APPROACH

### Calorimetric Approach

It was given that the system was a purely gassy system. The calorimetric approach generally chosen by the participants consisted of the following steps:

- Determination of the gas production rate in the reaction vessel at the vessel maximum allowable pressure ( $P_{MAP}$ ) using adiabatic calorimetry.

**Table 2.** Input data for the vent sizing

Vessel volume	$0.340\text{ m}^3$
Vent pipe diameter	0.08 m
Fill level	70%
Bach mass	207.06 kg
Bach volume	$0.238\text{ m}^3$
Liquid density	$870\text{ kg}/\text{m}^3$
Vent opening pressure, Pset	4.5 bar abs
<b>MAP<sup>5</sup></b>	<b>7 bar abs</b>
Temperature rise rate due to the fire	$0.5\text{ }^{\circ}\text{C}/\text{min}$
$C_d$ of the vent line	0.816

**Table 3.** Participants' experimental facilities used in this study

Participants		A	B	C	D	E	F	G
Calorimeters	DSC		✓			✓		
	ARC					✓		
	VSP2		✓		✓		✓	
	Phitec	✓				✓		✓
	ARSST			✓	✓			
Reactor vessels	0.1 litre						✓	
	0.8 litre				✓			
	1 litre							✓
	10 litres				✓			

- Calculation of the venting flow using flow models. An assumption was made on the nature of the flow (gas or two-phase);
- Calculation of the vent area corrected by the discharge coefficient.

#### Similarity Approach

Participants D and F ran some venting tests with 40% w/w Dicumyl Peroxide solution at the following scales: 0.1 litres, 0.8 litre, and 10 litres. Some results are presented in 3.6. These experiments were done in order to compare the DIERS approach with an approach based on the similarity principle described above (scale up using a constant vent area to volume ratio  $A/V$ ).

Participant G ran some venting tests at 1 litre scale using a 25% w/w Dicumyl peroxide solution.

#### ROUND ROBIN RESULTS: CALCULATED VENT AREAS

Figure 2 shows the calculated vent areas. There are significant differences in the results. The ratio of the vent pipe area

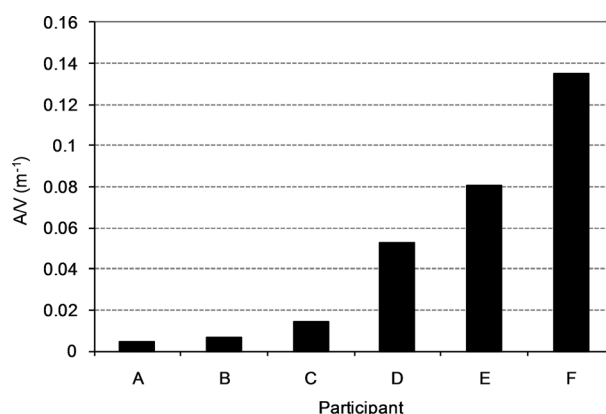
**Figure 2.** Calculated vent area/volume ratio

to the vessel volume being  $0.01478 \text{ m}^{-1}$ , participants D, E and F concluded that this reaction could not be carried out safely in the reaction vessel. Participants A, B and C concluded that it was possible.

Company G did some preliminary tests with the 40% w/w Dicumyl peroxide solution and concluded that this solution was too concentrated to be handled at large scale.

The following analysis aims to identify the major sources of the differences.

#### MEASUREMENT OF THE GAS PRODUCTION RATE

The assessment of the gas production rate at large scale ( $Q_G$ ) depends on the type of calorimetric test performed and their interpretation.

#### Differences in the Calorimetric Tests and Resulting $Q_G$

Table 4 summarises the test conditions and assumptions used by the companies in their calorimetric analysis.

**Table 4.** Summary of the test conditions for the calorimetric experiments and assumptions

	Participant					
	A	B	C	D	E	F
Calorimeter	Phitec II	VSP2	ARSST	VSP2	Phitec II	VSP2
Test conditions	Close cell	Close cell	Open cell	Open cell	Open cell	Open cell
Initial Pad Pressure (bara)	N/A	N/A	7	4.6	7	7
Correction of the heat rate ( $\Phi$ )	Yes	Yes	No	No	No	No
Correction of the gas production rate ( $\Phi$ )	No	Yes	No	No	No	No
Assumption of the gas temperature in the calorimeter	$T_{\text{gas}} = T_{\text{liquid}}$	$T_{\text{gas}} = T_{\text{liquid}}$	$T_{\text{gas}} = T_{\text{liquid}}$	Measured	Average: $(T_{\text{liquid}} + T_{\text{amb}})/2$	$T_{\text{gas}} = T_{\text{amb}}$
Calculation of the gas production rate takes with thermal expansion of the gas	Yes	Yes	No	No	No	No
Nature of the gas	$\text{CH}_4 + \text{CO} + \text{CO}_2$	$\text{CH}_4$	$\text{CO}_2$	$\text{CH}_4$	$\text{CH}_4$	$\text{CH}_4$
Flow type	Gas	Gas	Gas	Two-phase	Two-phase	Two-phase
Model used for the calculation of the vented flux	Gas venting	Gas venting	Gas venting	Tangren	Omega	Tangren

Open cell and closed cell tests were performed. A brief description on the tests is given in the Appendix.

Participants A and B performed closed cell testing in PHITEC II and VSP2 calorimeters respectively. The reasons for choosing the closed tests over open tests are the following:

- Good calorimetric method where the sample and gas phase temperatures are well defined and known;
- The influence of the total pressure on the gas dissolved in the liquid phase was observed by varying the test cell filling ratio;
- Poor precision on the gas temperature and on the rate of gas production with an open test.

Participants C, D, E and F did the vent sizing calculation using open cell testing under a gas pressure pad (aiming at limiting any vaporisation effects, while giving similar amounts of gas dissolution to the large-scale case). These tests were carried out in the VSP2, PHITEC II and ARSST calorimeters. The reasons for choosing the open tests over closed tests are the following:

- The open configuration limits the gas dissolution effects (lower pressure in the containment vessel) and therefore gives a better estimation of the gas production rate
- The reaction can be violent and lead to the bursting of the cell with the closed configuration (especially for gassy systems).

Participants A and B corrected the heat release rate data to take into account the effect of test cell thermal capacity ( $\phi$ ). Participant B also applied the heat rate correction method to the gas production rate using a first order method. The justification for the methodology lies in the strong correlation between the rate of pressure rise and the heat-rate in the experiments. The other participants did not apply any correction to the adiabatic data with no obvious justifications.

The calculation of the volumetric gas generation rate ( $Q_G$  in  $m^3/s$ ) consists on calculating the volumetric gas

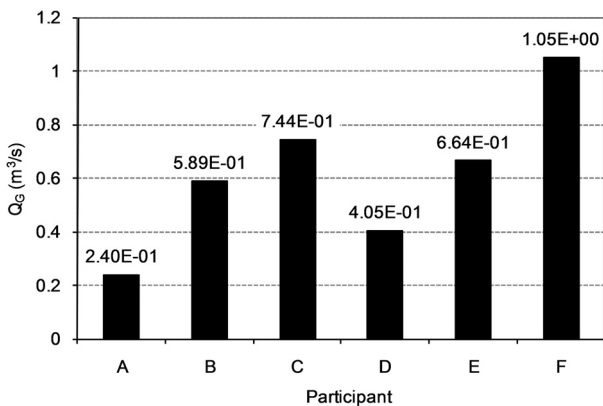

Figure 3. Calculated maximum volumetric gas generation rate ( $Q_G$ )

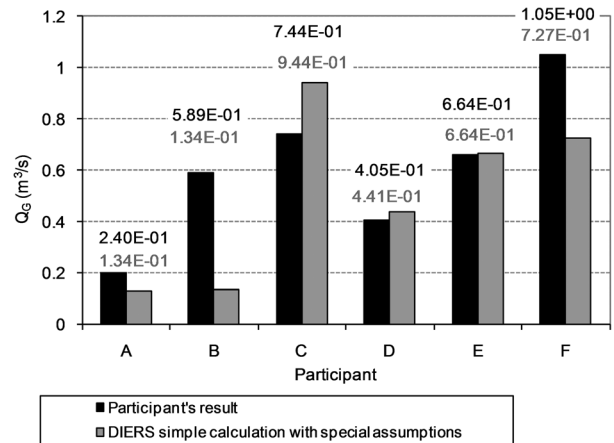

Figure 4. Calculation of  $Q_G$  comparison of participant's data versus DIERS common calculation

generation rate in the reactor vessel at  $P_{MAP}$  using the maximum specific gas production rate (in  $kg\ gas \cdot kg^{-1} \cdot s^{-1}$ ) measured in the calorimeter. The participant generally followed one of the methods presented in the Appendix.  $Q_G$  varies within a factor of 4 between 0.24 and  $1.05\ m^3/s$  (Figure 3). Participant A found a particularly low value for  $Q_G$  ( $0.240\ m^3/s$ ).

The  $Q_G$  calculated with closed cell data was not necessarily less than the ones calculated with open cell data (B compared to D). The  $Q_G$  calculated with open cell data show significant variations (factor of 2.6).

A deeper analysis is required to understand these differences.

Origin of the Differences in Calculated Values of  $Q_G$

$Q_G$  was recalculated from the participant's raw calorimetric data using the simple DIERS approach derived in Appendix with the following additional conditions<sup>1</sup>:

- The calorimetric data are not corrected for the thermal test cell capacity ( $\phi$ );
- For open cell tests, the temperature of the gas in the calorimeter containment vessel is assumed to be an average temperature, between the liquid temperature and ambient temperature  $T_e = (T_{liquid} + T_{ambient})/2$ ;
- For closed cell tests the temperature of the gas in the test cell is assumed to be the same as the liquid sample.

Figure 4 shows the  $Q_G$  calculated with this common approach (grey bars). The following points are to be noticed:

- With the common DIERS approach used here, it is to be noticed that the raw adiabatic data from companies A and B lead to very close values of  $Q_G$ . This means that the difference of  $Q_G$  calculated by the participants

<sup>1</sup>There is here no claim that this is the methodology to be used. The chosen approach is only for the sake of the comparative analysis.

A and B lies in the correction and interpretation of the data.

- Raw closed cell data gives lower gas production rates than open cell a factor of 5 between average values).
- Even with the same method large differences are noticed within the results with open cell tests (a factor of 2; companies C to F). This could be due to the adiabaticity factor ( $\phi$ ) effect (e.g. ARSST/VSP2) or to the accuracy of the simulation of the external heating ( $0.5^\circ\text{C}/\text{min}$ ). Small deviations from this value could indeed have an influence on the maximum temperature and pressure. This means that the differences in  $Q_G$  obtained by the participants may lie in the interpretation of the results but also in the experimental data themselves.

These values of  $Q_G$  were then compared to the ones calculated by each company (Figure 4). The observed differences are explained as follows:

**Participant A (closed cell testing):** the noted difference is probably due to the calculation method used by the participant, which needs more clarification.

**Participant B (closed cell testing):** The  $Q_G$  of this participant is 4.4 times higher than with the common approach. The observed difference is mainly related to the fact that this participant corrected the pressure and temperature data to take the  $\phi$  factor into account. The value of  $Q_G$  measured in a closed configuration and *corrected* by the  $\phi$  factor is of the same level (and not necessarily less) than the  $Q_G$  measured in an open configuration and *uncorrected*.

**Participant C (open cell testing):** The noted difference is related to the fact that this participant assumed the gas temperature in the containment vessel ( $T_g$ ) to be the same as the liquid temperature. There is experimental evidence that the gas temperature in the containment vessel is lower than the liquid temperature but higher than the ambient temperature [4,5] (as measured by participant D). Assuming that the gas and the liquid are at the same temperature would then tend to decrease the calculated value of the volumetric gas generation rate (in this particular case by approximately 25%).

**Participant D (open cell testing):** The noted difference is quite small and comes from the fact that the participant used a measured value of the gas temperature in the containment vessel (open cell) instead of assuming it as being an average value between the liquid and the ambient temperature, as in the simple method used for comparison.

**Participant E (open cell testing):** No differences are noted indicating that the same approach is used.

**Participant F (open cell testing):** A significant difference is noted. In this case the participant assumed that the temperature of the gas in the containment vessel is the same as the ambient temperature. This assumption therefore tends to increase the calculated value of  $Q_G$  (in a conservative way, in this particular case by approximately 45%).

#### CALCULATION OF THE VENTED MASS FLUX ( $G$ )

The calculation of the vent area requires the calculation of the venting flow using flow models. The vented mass flux at  $P_{MAP}$  was calculated using one-phase or two-phase

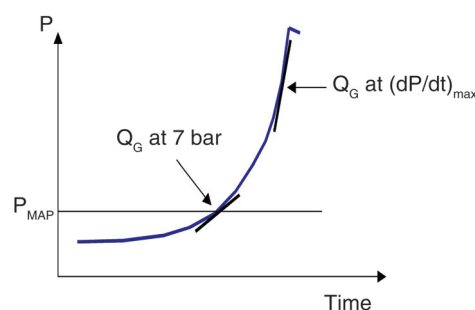

**Figure 5.**  $Q_G$  at  $P_{MAP} = 7$  bar in closed cell test used by participant A to predict the flow type using level swell calculations

relief models. Prior to the use of such models, an assumption is to be made regarding the nature of the vented fluid (one or two-phase venting).

Participants A and B made the assumption of gas venting only for the following reasons:

- Venting tests for the decomposition of neat di-cumyl peroxide were reported in the literature. Some tests with low external heating rates ( $0.8^\circ\text{C}/\text{min}$  to  $2^\circ\text{C}/\text{min}$ ) and large vessels seemed to fit the DIERS gas-only vent sizing and UN methods [3].
- Venting tests and determinations of the release type with 40% DCP in butyrate [4] was found to be all-gas at 0.1 litre scale, also in the case of an initial rate of temperature scan of  $0.5^\circ\text{C}/\text{min}$ .<sup>2</sup>
- A significant vent oversize was obtained if the homogeneous assumption and gas + liquid homogeneous two phase release were assumed.

Participant A did some level swell calculations to determine whether the venting at large scale at  $P_{MAP}$  would be gas or two-phase. This evaluation was done at the maximum allowable pressure ( $P_{MAP} = 7$  bar) in a closed cell experiment (and not the maximum pressure rise rate, see Figure 5). A corresponding value of  $Q_G$  was calculated.<sup>3</sup>  $Q_G$  was in turn used to calculate the minimum void fraction necessary to have single-phase flow (assuming a churn-turbulent behaviour). The calculated value of  $Q_G$  being relatively low when the pressure is 7 bar in the close cell (far from the maximum gas production rate), the calculation leads to the conclusion that the venting will be gas only. This approach is questionable as it gives an indication of the flow type at vent opening but not at  $P_{MAP}$  where the gas production rate is close to maximum.

For participant C, the vent sizing formula does not require the calculation of a two phase mass flux and uses

<sup>2</sup>The use of such tests as experimental evidence that the venting is going to be gas at 340 litres is therefore questionable.

<sup>3</sup>This value is significantly lower (by three orders of magnitude) than the value of  $Q_G$  used for the vent sizing calculation (based of  $dP/dt$  max in the close cell).

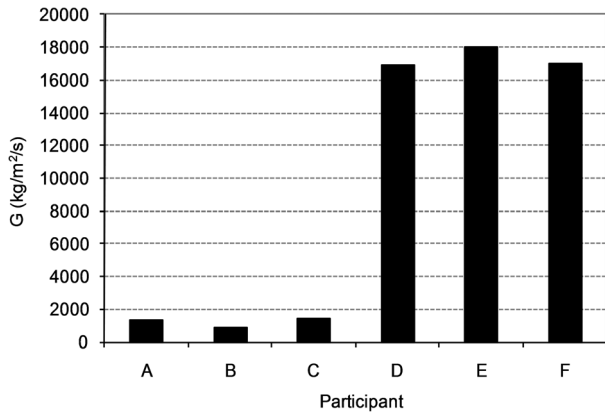

Figure 6. Calculation of the mass flux

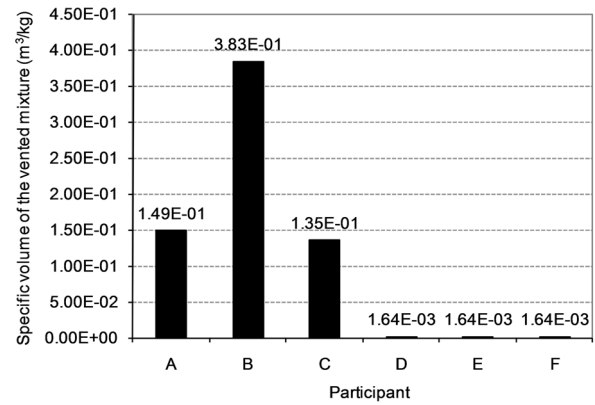

Figure 7. Calculation of the specific volume of the vented mixture

the all gas venting equation. This does not imply that participant C assumes gas venting only at large scale.

Participants D, E and F performed the calculations assuming homogeneous two-phase venting. This approach was simply chosen as recommended by the DIERS methodology as a conservative approach when no evidence of one-phase venting is available. These participants assumed homogeneous reactor contents with the specific volume of the vented mixture ( $v_i$ ) given by the following equation:

$$v_i = V/m_0 \tag{1}$$

Figure 6 shows that application of the gas relief venting model for  $P_{MAP} = 7$  bar by companies A, B and C gave approximately the same results (less than 2000 kg/m<sup>2</sup>/s). The major differences in the calculated values of the specific volume of the vented gas, showed in Figure 7, come from the assumption made on the molar mass of the vented gas (Table 4).

The two-phase venting models assuming non-flashing two-phase flow (frozen flow) were used by participants D, E and F. The participants used particularly the Omega method for turbulent flow [6] and Tangren *et al's* method [7]. Figure 6 shows that the application of the above two-phase relief venting model (with homogeneous reactor content assumption) for  $P_{MAP} = 7$  bar gave approximately the same results (around 17000 kg/m<sup>2</sup>/s). No major differences were noted regarding the calculated values of the specific volume of the vented fluid (Figure 7).

The analysis of the calculated mass flux highlighted the following:

- The results were comparable amongst participants who assumed single-phase venting. The results were also comparable amongst those who assumed two-phase venting. This means there is a general good agreement on the way such methods should be applied.<sup>4</sup>

<sup>4</sup>This is not a statement on the validity of the method itself.

- As expected, the values of the vented mass flux calculated for the single-phase venting case are significantly lower than the ones calculated for the two-phase venting case. The gap between the two approaches is more than one order of magnitude.

The assumption on flow type is then the major source of difference in the calculated vent areas. The underlying reasons for the choice of the one-phase venting assumption over the two phase venting assumption remain unclear.

#### CONCLUSION ON THE RESULTS FROM THE CALORIMETRIC APPROACH

The above analysis highlighted the fact that the experimental conditions of the calorimetric tests can have a significant influence on the estimated gas production rate at large scale ( $Q_G$ ) and so the size of the final vent area. The major sources of difference are:

- The choice of open or close configuration for the adiabatic test;
- The correction of the adiabatic data to take into account the adiabaticity factor;
- For open cell test, assumptions on the gas temperature, when not measured.

Regarding the calculation of the vented mass flux, there is a general good agreement on the way that one or two phase flow models should be applied. The calculation of the vented mass flux stays however largely responsible for the differences in calculated vent area in terms of the assumption of one-phase or two-phase venting. The reasons for choosing the one-phase venting assumption, which gives a lower mass flux and therefore a lower vent area, over the two-phase venting assumption are not clear and the assumption is not strongly justified.

More work is needed regarding the prediction of the nature of the vented fluid at large scale.

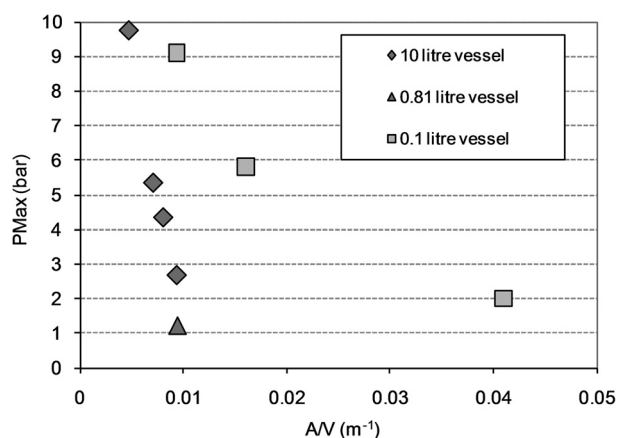

Figure 8. Venting data at 10 litres, 0.8 litre and 0.1 litre scales

#### COMPARISON OF THE CALCULATED VENT AREAS / SIMILARITY APPROACH

The vent sizes calculated with the calorimetric approach were compared to the vent sizes determined directly by venting experiments (similarity approach). This allows a comparison between the DIERS approach and the UN vent sizing approach for peroxide systems.

Participants E and F carried out some venting tests with 40% Dicumyl Peroxide in butyrate in the same conditions as stated in this Round Robin exercise (Table 2) at three scales: 0.1 litres (modified VSP2) [4, 5, 8], 0.8 litre, and 10 litres (UN 10 litres test).

Figure 8 shows the results obtained from the venting experiments. For a given  $A/V$ , the 10 litre vessel gave a lower  $P_{max}$  than the 0.1 litre vessel. It is also interesting to note that the decrease rate of  $P_{Max}$  when increasing  $A/V$  is higher for the 10 litre vessel than the 0.1 litre vessel. One of the underlying reasons may be linked to the effect of the vent opening on the level swell which is likely to be more important when increasing the volume of the vessel. If the similarity approach for vent sizing is chosen, i.e. if the 10 litre vessel results are used, to size the vent of the 340 litre vessel of concern in the Round Robin exercise, the suitable  $A/V$  for  $P_{MAP} = 7$  bar would be approximately  $0.006 \text{ m}^{-1}$ .

Figure 9 shows the comparison between the calorimetric approach and the similarity approach for this Round Robin exercise. The two approaches diverge significantly for vent sizing calculations performed assuming two-phase venting only. This highlights the fundamental difference between the DIERS method for gassy systems (conservatively assuming two-phase venting when gas flow is uncertain) and the UN 10 litre vessel method. A good agreement between the two approaches is observed for vent sizing calculations performed assuming gas venting only, at least at 0.1 and 10 litre scale.

However, the question of the validity of the similarity approach remains regarding the scale up of the result to large scale vessel, such as the 340 litre vessel in this paper.

Large scale tests would allow the comparison, the validation and the improvement of both these methods.

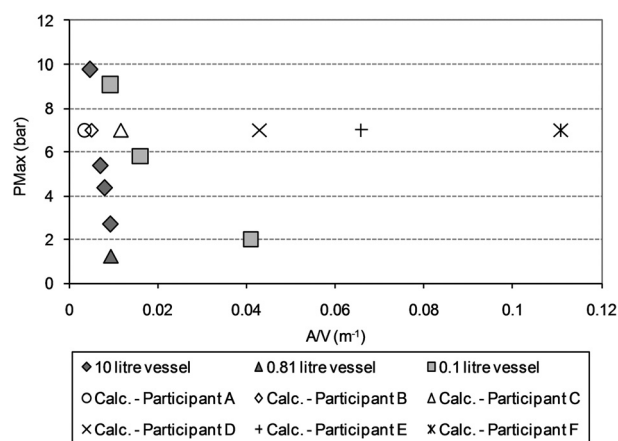

Figure 9. Comparison of calculated  $A/V$  and venting data at 10 litres, 0.8 litre and 0.1 litre scales

#### CONCLUSIONS

A Round Robin exercise on 40% w/w dicumyl peroxide in butyrate solvent was organised to achieve a cross comparison of different participants' results and methods regarding a typical vent sizing problem for a gassy system. Very different results were obtained.

An in-depth analysis of the observed differences showed that the experimental conditions of the calorimetric tests and their interpretation can have a significant influence on gas production rate at large scale ( $Q_G$ ) and then the size of the final vent area. The major sources of differences are:

- The choice of open or closed configuration for the adiabatic test (factor of 5);
- The correction of the adiabatic data to take into account the thermal capacity;
- For an open cell test, assumptions on the gas temperature, when not measured.

Additional work on the use of adiabatic calorimeters for gassy systems, and particularly the test conditions, would contribute to a better assessment of the gas production rate for a given gassy system. The comparison of the calculated vented mass flux showed that there is general good agreement on the way that the one or two phase flow model should be applied. This calculation stays largely responsible for the differences in calculated vent area. The critical factor lies in the assumption on the nature of the vented mass flow (gas or two-phase). However, the reasons for choosing the one-phase venting assumption, which gives a lower vent area, over the two-phase venting assumption remain unclear and not strongly justified.

More experimental and modelling work is therefore needed regarding the prediction of the nature of the vented flow at large scale (one or two-phase flow).

The calorimetric and the similarity approaches for vent sizing were shown to diverge significantly for vent sizing calculations performed assuming two-phase venting

only. Large scale tests would allow the comparison, the validation and the improvement of both these methods.

**APPENDIX: DIERS METHODOLOGY FOR GASSY SYSTEMS \_ CALCULATION OF THE MAXIMUM GAS PRODUCTION RATE [1,9]**

DIERS vent sizing methodology for gassy system is based on the following equation:

$$GA_{ideal} v_i = (v_g)_{P_{MAP}} m_0 \dot{m}_{g \max} \quad (2)$$

The terms relative to the gas specific volume at  $P_{MAP}$  and the maximum gas production rate are assessed using adiabatic calorimetry data.

$A$  is the cross-sectional area of the ideal nozzle. The vent area ( $A$ ), taking into account the discharge coefficient is given by:

$$A_{ideal} = AC_D \quad (3)$$

The right-hand side of equation (2) above corresponds to the maximum volumetric gas generation rate in the reaction vessel ( $Q_G$ ):

$$Q_G = (v_g)_{P_{MAP}} m_0 \dot{m}_{g \max} \quad (4)$$

The specific maximum gas production rate is assessed by measuring the maximum pressure rise rate resulting from the gas production for a given quantity of reactant and converting it into a maximum specific gas production rate using the following equation:

$$\dot{m}_{g \max} = \frac{1}{m_t} \left( \frac{m_{g,e} dP_e}{P_e dt} - \frac{m_{g,e} dT_e}{T_e dt} \right)_{at(dP/dt)_{\max}} \quad (5)$$

$$\dot{m}_{g \max} = \frac{1}{m_t} \left( \frac{m_{g,e} dP_e}{P_e dt} - \frac{m_{g,e} dT_e}{T_e dt} \right)_{at(dP/dt)_{\max}}$$

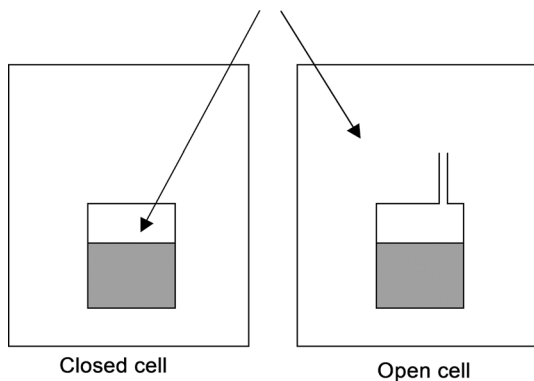

**Figure 10.** Calculation of the maximum gas production rate in open and closed configurations

The index  $e$  indicates that the parameter is directly measured in the calorimeter. For closed cell tests these parameters are evaluated in the test cell. For open cell tests they are evaluated in the containment vessel (see Figure 10).

$T_{P_{MAP}}$  is the temperature of the gas at  $P_{MAP}$ . This temperature is assumed to be the same as the liquid temperature at  $(dP_e/dt)_{\max}$  in the calorimetric test.  $Q_G$  at  $P_{MAP}$  is then given by:

$$Q_G = \frac{m_0 RT_{P_{MAP}}}{m_t P_{MAP} M_{wg}} \left( \frac{m_{g,e} dP_e}{P_e dt} - \frac{m_{g,e} dT_e}{T_e dt} \right)_{at(dP/dt)_{\max}} \quad (6)$$

For open cell, if the temperature of the gas in the containment vessel does not change greatly over time,  $Q_G$  reduces to [9]:

$$Q_G = \frac{m_0 T_{P_{MAP}}}{m_t T_e} \frac{V_e}{P_{MAP}} \left( \frac{dP_e}{dt} \right)_{\max} \quad (7)$$

**NOMENCLATURE**

$A$	surface area of the bursting disc (m <sup>2</sup> )
$A_{ideal}$	surface area of the ideal nozzle (m <sup>2</sup> )
$C_D$	Discharge coefficient (-)
$dT/dt$	Temperature rise rate (K/s)
$dT_e/dt$	Gas temperature rise rate in the adiabatic calorimer (K/s)
$dP/dt$	Temperature rise rate (K/s)
$dP_e/dt$	Pressure rise rate in the adiabatic calorimer (Pa/s); in the cell for closed cell tests, in the containment vessel for open cell test.
$G$	Vented mass flux (kg/m <sup>2</sup> /s)
$m$	Reactant mass (kg)
$M_{wg}$	Molecular weight of the gas (kg/mole)
$\dot{m}_{g \max}$	Specific gas production rate (kg of gas/kg/s)
$m_{g,e}$	Mass of gas in the adiabatic calorimeter (kg)
$m_0$	Initial reactant mass (kg)
$m_t$	Sample mass in the adiabatic calorimeter (kg)
$P$	Pressure (bara)
$P_e$	Pressure in the adiabatic calorimer (Pa); in the cell for close cell tests, in the containment vessel for open test.
$P_{MAP}$	Vessel maximum allowable pressure (bara)
$Q_G$	Volumetric gas production rate at large scale (m <sup>3</sup> /s)
$T$	Temperature of the liquid (K)
$T_e$	Temperature of the gas in the adiabatic calorimer (K); in the cell for close cell tests, in the containment vessel for open test.
$T_{P_{MAP}}$	Temperature of the gas at $P_{MAP}$ (K)
$V$	Vessel volume (m <sup>3</sup> )
$V_e$	Volume occupied by the gas on the adiabatic calorimeter (m <sup>3</sup> )
$v_g$	Specific volume of the gas (m <sup>3</sup> /kg)
$v_i$	Specific volume of the vented mixture (m <sup>3</sup> /kg)
$\phi$	Adiabaticity factor, phi factor (-)



**ACKNOWLEDGEMENT**

The authors wish to acknowledge the following companies for their participation in this work:

École Nationale Supérieure des Mines de Saint Etienne (FR), Health & Safety Laboratory (UK), INERIS (FR), Rhodia Recherches et Technologies (FR), Fauske & Associates (US), Stazione sperimentale per i combustibili (IT), Sanofi-Aventis (FR).

**REFERENCES**

1. Fischer H.G., Forrest H.S., Grossel S.S., Huff J.E., Muller A.R., Norhona J.A., Shaw D.A., Tilley B.J., *Emergency Relief System Design using DIERS Technology*, The Design Institute for Emergency Relief Systems (DIERS) Project Manual, AIChE 1992.
2. UN Economic Commission for Europe, Committee of Experts on the Transport of Dangerous Goods and on the Globally Harmonized System of Classification and Labeling of Chemicals (2003). Example of a test method for Vent sizing. Appendix 5 in "*Recommendations on the Transport of Dangerous Goods, Manual of Tests and Criteria*" pp. 421–425.
3. Hare J.A., Adams W.D., *Evaluation of the UN vent sizing method for organic peroxide portable tanks*, Proceedings of IChemE Hazards XVI Symposium, Nov 2001, pp. 133–146, IChemE ISBN 0-85295-441-7.
4. Minko W., *Emballlements thermiques de réactions: Etude des méthodes de dimensionnement des événements applicables aux systèmes hybrides non tempérés*, PhD thesis, Ecole Nationale Supérieure des Mines de Saint-Étienne, December 2008. <http://tel.archives-ouvertes.fr/tel-00372536/fr/>
5. Véchet L., *Sécurité des procédés; emballement de réaction; dimensionnement des événements de sécurité pour systèmes « gassy » ou hybrides non tempérés*, PhD thesis, École Nationale Supérieure des Mines de Saint-Étienne, December 2006, <http://tel.archives-ouvertes.fr/tel-00136503/fr/>
6. Leung, J.C., *Two-phase flow discharge in nozzles and pipes — a unified approach*, Journal of Loss Prevention in the Process Industries, Volume 3, Issue 1, 27–32, 1990.
7. Tangren R.F.; Hodge C.H.; Seifert H.S., *Compressibility Effects in Two-Phase Flow*, J. Appl. Phys., 20, 637–645, 1949.
8. Véchet L., Bigot J-P., Testa D., Kazmierczak M., Vicot P., *Runaway reaction of non-tempered chemical systems: Development of a similarity vent-sizing tool at laboratory scale*, J. Loss Prev. Process Ind. 21, 359–366, 2008.
9. Etchells J., Wilday J., *Workbook for chemical reactor relief system sizing*, HSE Books, 1998.